

# ZETA

2.3" Bold Linear



ZETA  
Suspended

## Exquisite Clean lines. Sleek styling

This ZE 2.3" direct/Indirect solution does it all, in a system with a small scale 2.3" extruded profile that not only provides straight lines but also well-controlled ambient lighting with separate control of direct and indirect lighting. It's an excellent choice for commercial and retail ambient applications

- Available in suspended, recessed, surface and wall mount.
- Individual units, continuous runs or patterns with 90-degree or 120-degree joiners.
- Direct/Indirect light may be specified and controlled independently.
- Diffuser, louver, micro reflector and deep regressed lens options.
- Lumen output range:
  - Direct up to 1050 lumens per foot
  - Indirect up to 1150 lumens per foot

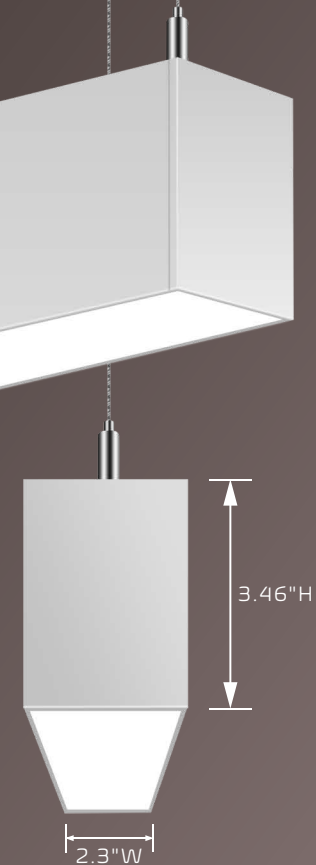

## Combining Architectural Aesthetics With Visual Comfort

Flexible and sophisticated, the linear lighting families featured in top finishes, with professional optics and unprecedented performance.

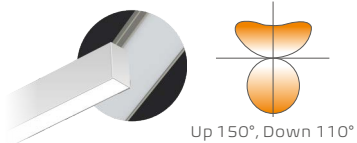

Up 150°, Down 110°

### Diffuser

It allows the light to custom the diffuser lengths, up to 42'.



Up 150°, Down 80°

### Louver

Straight blade louver, allows the light to diffuse for a direct and indirect lighting combination.

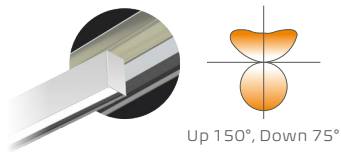

Up 150°, Down 75°

### Deep Regressed

A snap-in lens for easy custom colors and visual comfort.

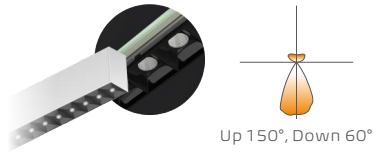

Up 150°, Down 60°

### Micro Reflector

Exclusive low glare modular optics, UGR<15.

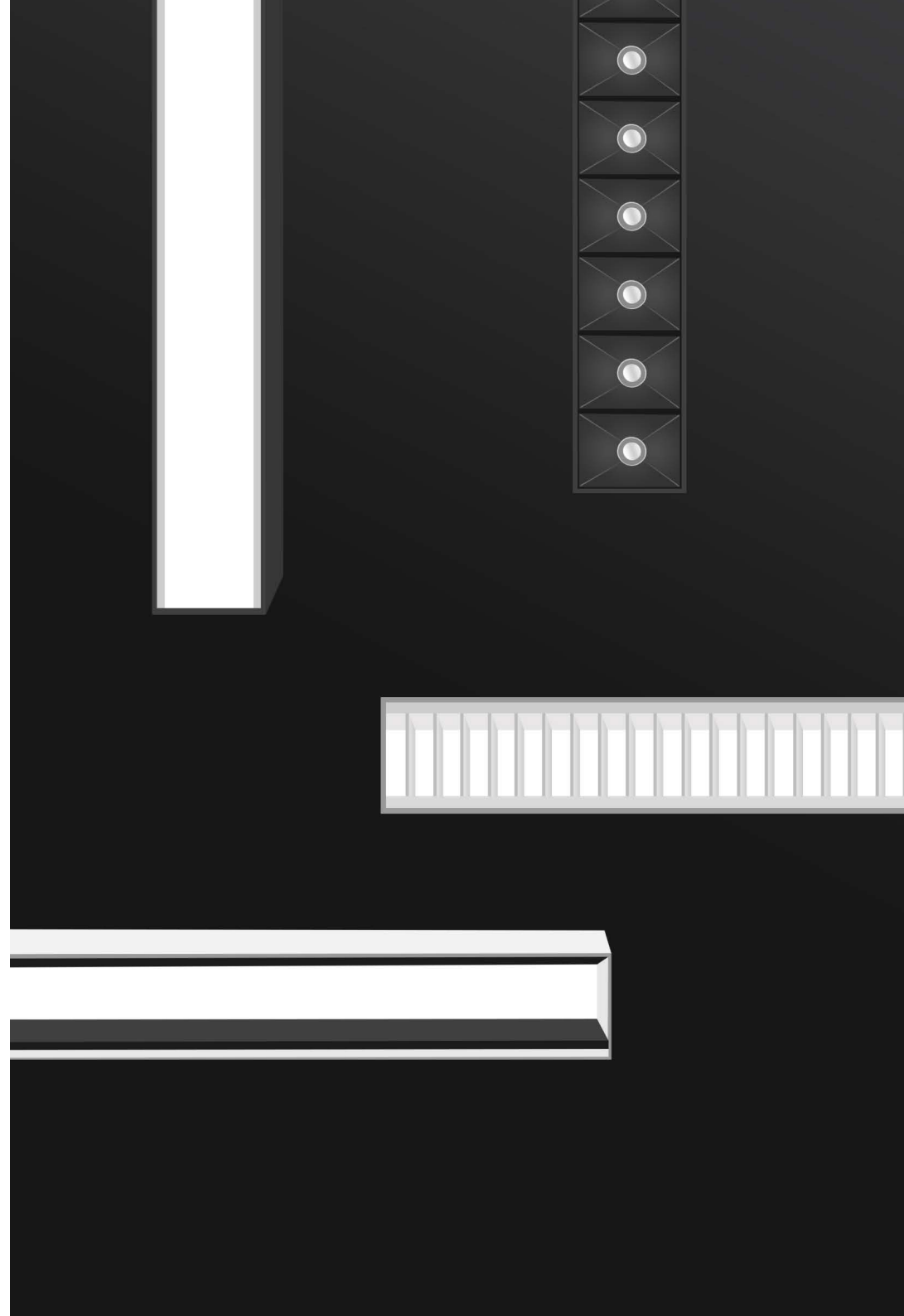



## Powerful "7 IN 1" 7 Lighting Distributions

The Zeta series can provide smooth direct or indirect lighting distribution.  
\* "7 in 1" 7 embedded lighting distributions adjusting by dip switch.

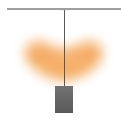

100% UP

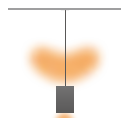

90% Up, 10% Dn

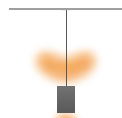

70% Up, 30% Dn

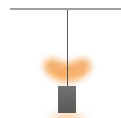

50% Up, 50% Dn

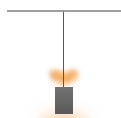

30% Up, 70% Dn

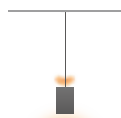

10% Up, 90% Dn

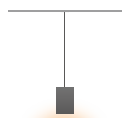

100% Dn

\* Smoothly control direct/indirect lighting distributions  
by a remote 0-10V dimmer.

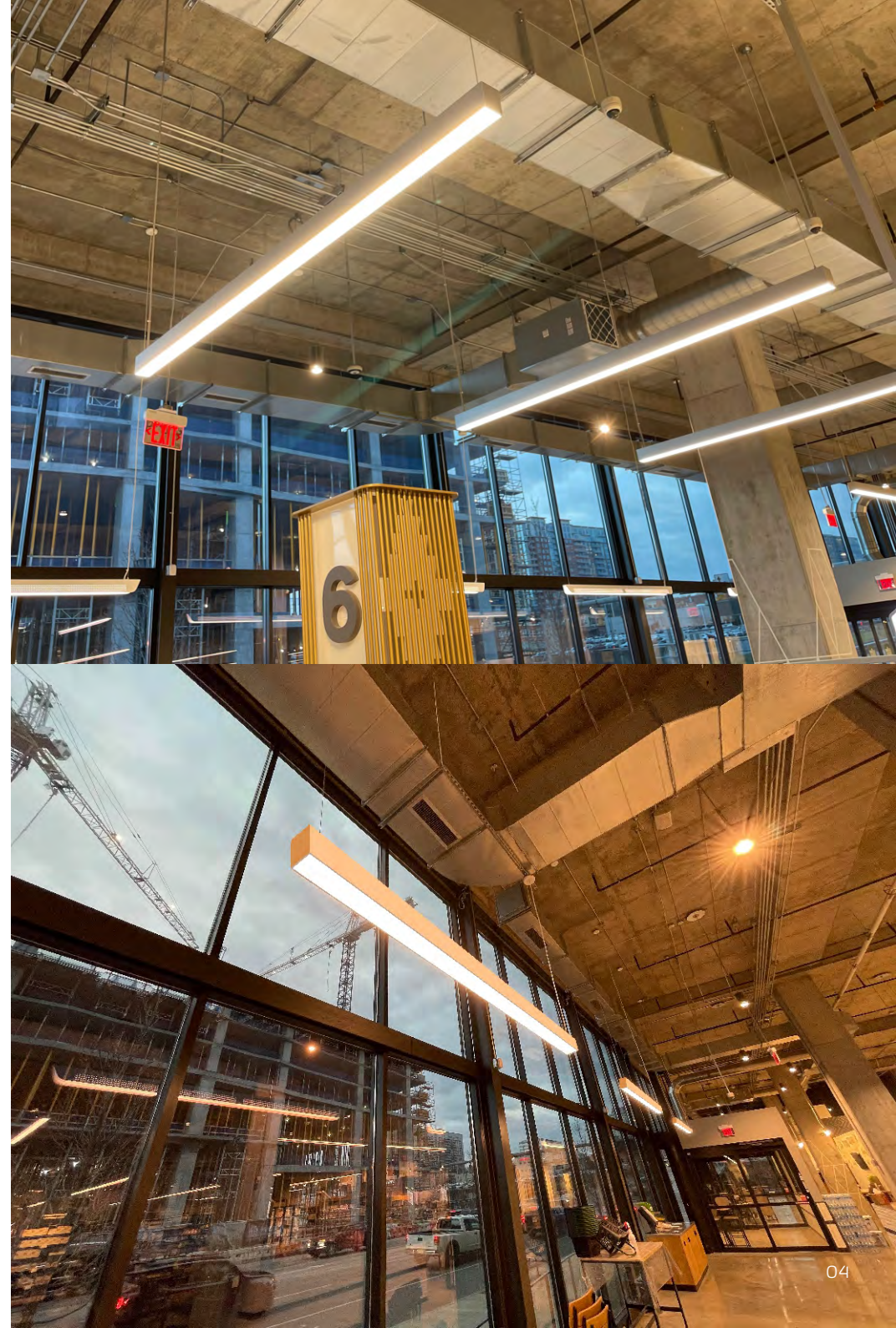

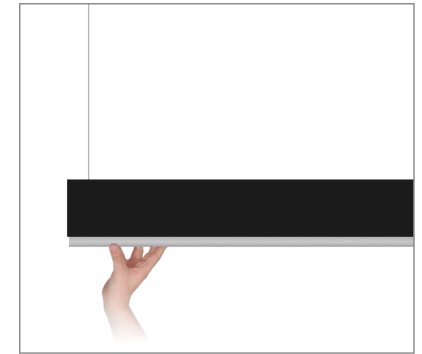
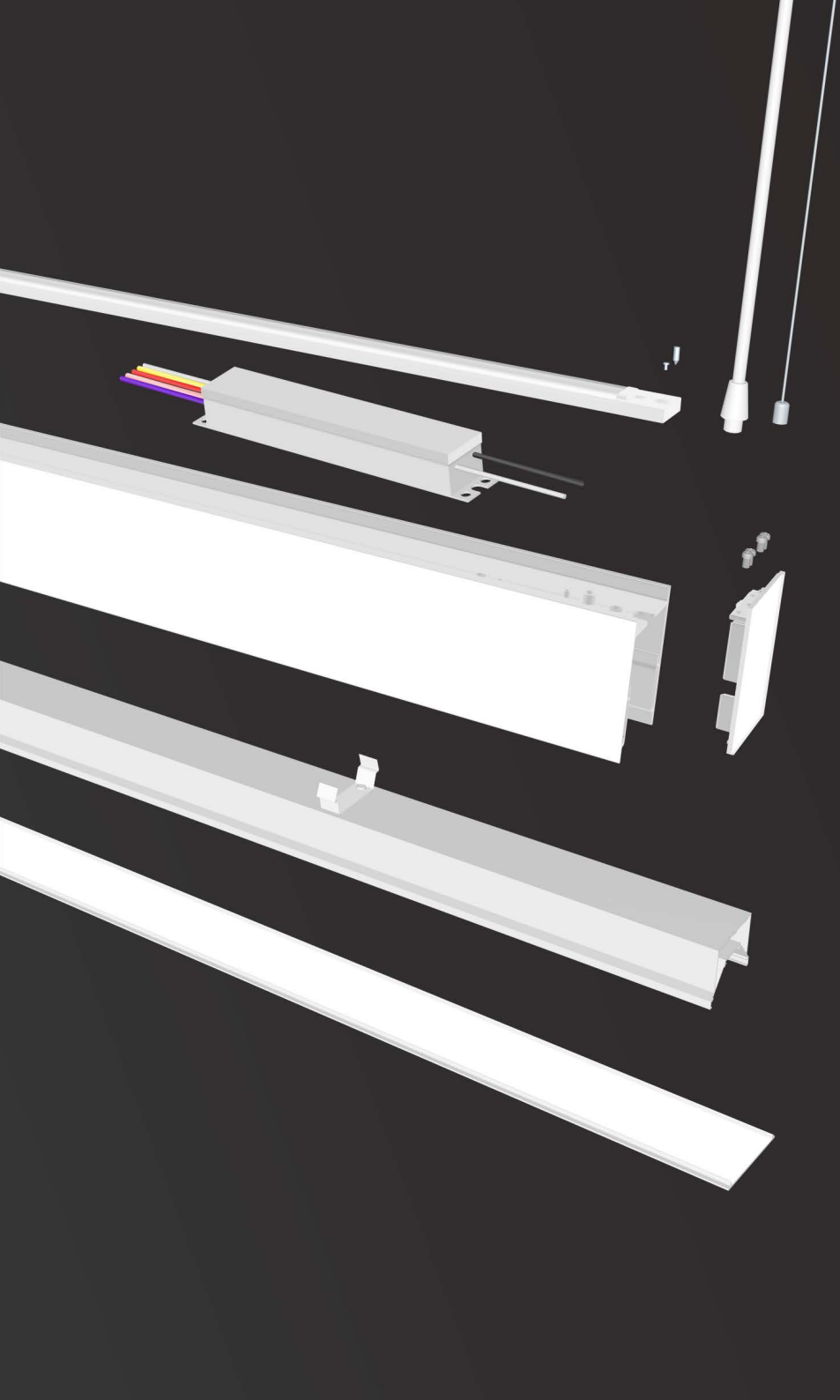

## Elegant Design Blending Precise Performance

### Functional Style

Built on the core of its modern, the Zeta series allow easy access to critical components to simplify installation or in the event that repair or replacement of different CCT becomes necessary.

### Ease Of Installation

Engineered to help reduce installation costs, with a simple joining and alignment mechanism that optimizes the stability and straightness of patterns and continuous runs





## The Art of Design Flexibility

All linear line products offer the freedom to create truly dynamic spaces. 5 joiners make it easy to create multiple fixture configurations for exceptional design flexibility. For additional design flexibility, individual or row-mounted options are available in a variety of run lengths and lamp configurations.



'I' Joiner



'L' Joiner



'T' Joiner

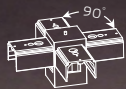

'+' Joiner



'Y' Joiner



'V' Joiner



'Z' Pattern

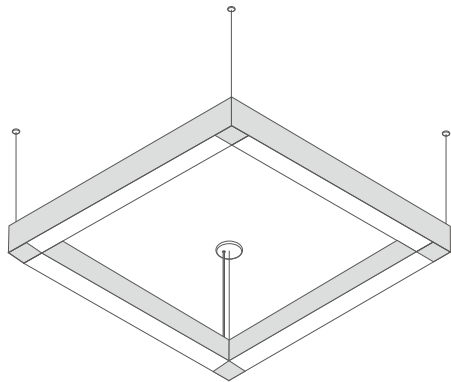

### Product Performance

Shape:	□	Mounting:	Suspended
Qty	Parts		
4	4' Linear Light (Direct / Indirect)		
4	L Joiner		
0	End Cap		
4	Suspension Kit		
1	4" Power Feed Canopy		
3	2" Non-power Feed Canopy		
1	AC Cable		





## Product Performance

Shape: Line   Mounting: Suspended	
Qty	Parts
4	4' Linear Light (Direct / Indirect)
4	— Joiner
2	End Cap
5	Suspension Kit
1	4" Power Feed Canopy
4	2" Non-power Feed Canopy
1	AC Cable
1	42' Continuous Roll-Out Lens

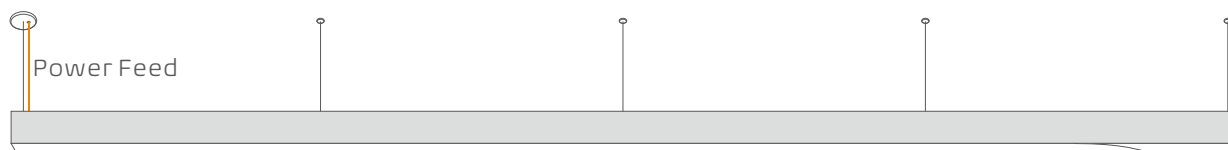

It is linear, available in runs of virtually any length.  
Each power feed works:

- Up to 40ft in 120V AC.
- Up to 100ft in 277V AC.

  
42' Continuous Roll





Flexibility for straight or angled connections, and the ability to connect another line on a different plane.

## 360° Bridge Bracket System - Z Joiner

Virtually limitless design possibilities

It allows for maximum flexibility for continuous runs whether straight or with turns at any horizontal angle, in single or multiple planes, which enables a wide range of lighting pattern configurations.

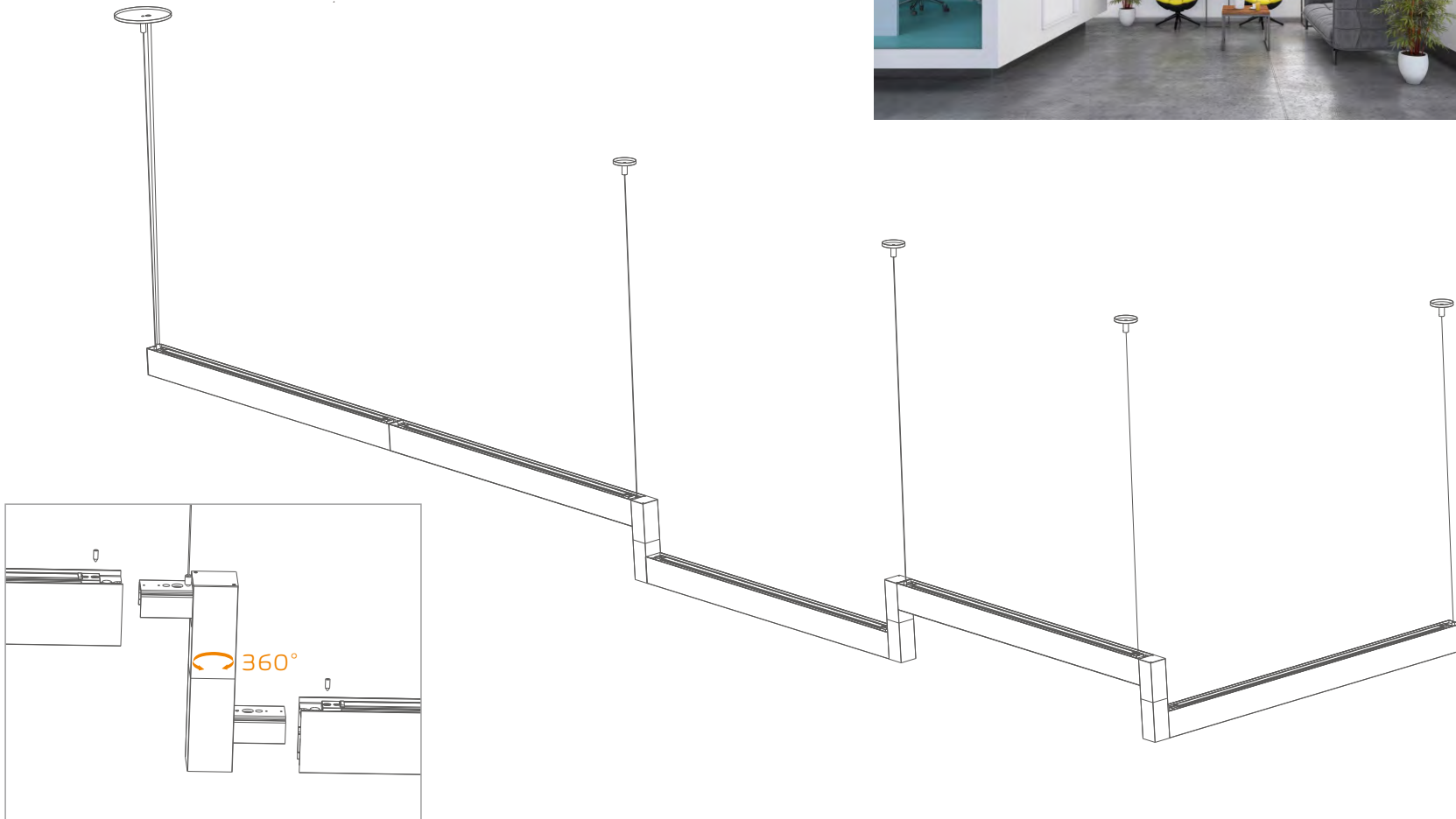





# Unparalleled Versatility

Various Mounting Options  
Come Unlimited Lighting Design

## Various Mounting Options



### Suspended

Best suited to spaces with generous ceiling heights. Light up the space to improve comfort with the indirect lighting option and various canopies.



### Surface

It is the ideal choice for low ceilings and minimal ceiling spaces. Surface mounted luminaires can be used effectively to enhance architectural features.

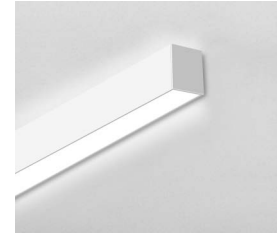

### Wall Mount

Delivers visually appealing ambient lighting and enhanced design and application flexibility.

## Quick Suspended T-grid / Dry Ceiling Compatible

### Canopy Style

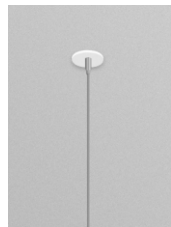

1.6" Round  
(Non Power Feed)

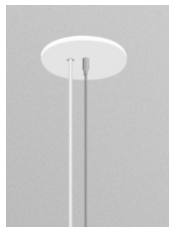

4.5" Round  
(Power Feed)

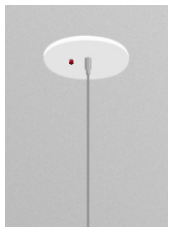

4.5" Round With  
Emergency Driver  
(Non Power Feed)

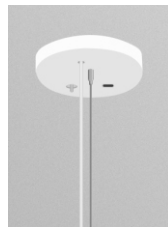

5.8" Round With  
Occupancy Sensor  
(Power Feed)

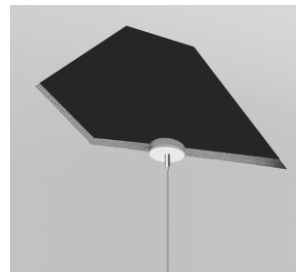

### Dry Ceiling / Off Grid

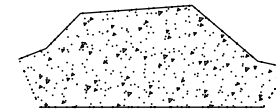

"Various Hard Ceilings"  
(Mount to J-box)

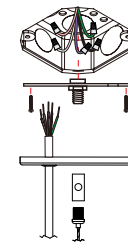

1.6" Square  
(Non Power Feed)



4.5" Square  
(Power Feed)

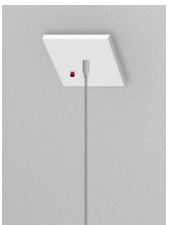

4.5" Square With  
Emergency Driver  
(Non Power Feed)

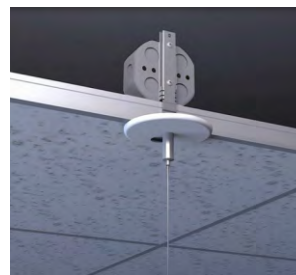

\*Please see the installation instruction for more details.

### Drop Ceiling / On Grid

Suspending the luminaire in the T-grid. Compatible for various T-grid, including 9/16" Flat, 9/16" Slot, 15/16" Flat.

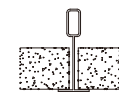

9/16" Flat Ceiling

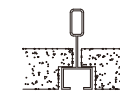

9/16" Slot Ceiling

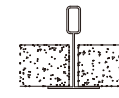

15/16" Flat Ceiling

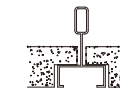

15/16" Slot Ceiling

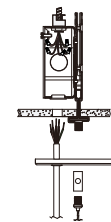















**Manufacturing HQ**  
2076 Jincheng Rd, Shajing Town,  
Shenzhen, China  
+86-755-61157553  
sales@oktlighting.com  
www.oktlighting.com

**Customer Service Center**  
10641 S Sam Houston Pkwy West,  
Suite 100, Houston, TX 77071  
+1-832-493-4790

@OKT Lighting. All right reserved. Product design and development is an ongoing process by OKT Lighting. We reserve the right to change specifications. Contact OKT for the latest product information or visit website for more.