



RISK OF FIRE AND ELECTRICAL SHOCK. FIXTURE MUST BE INSTALLED BY A QUALIFIED ELECTRICIAN ONLY IN ACCORDANCE WITH NATIONAL, LOCAL BUILDING AND ELECTRICAL CODES. DISCONNECT POWER AT ELECTRICAL PANEL BEFORE SERVICING.

IMPORTANT

1. Read all instructions.
2. Install in accordance with national and local electrical code regulations.
3. This product is intended to be installed and serviced by a qualified, licensed electrician.
4. Do not install in wet locations. For dry and damp use only.
5. Turn off electrical power before installing or servicing fixture in any way.
6. To reduce the risk of fire and overheating, make sure all connections are tight.
7. Under no circumstances can the lighting fixture be covered with heat insulation gasket or similar materials.

WIRING

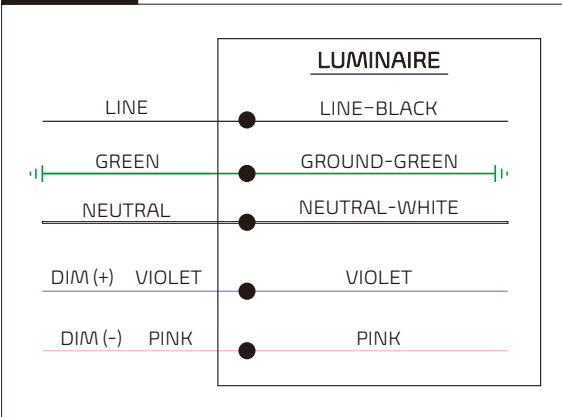

STRUCTURE OF LAMP

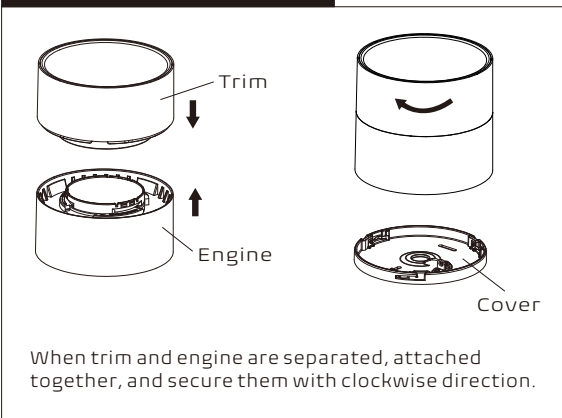

INSTALLATION

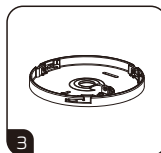
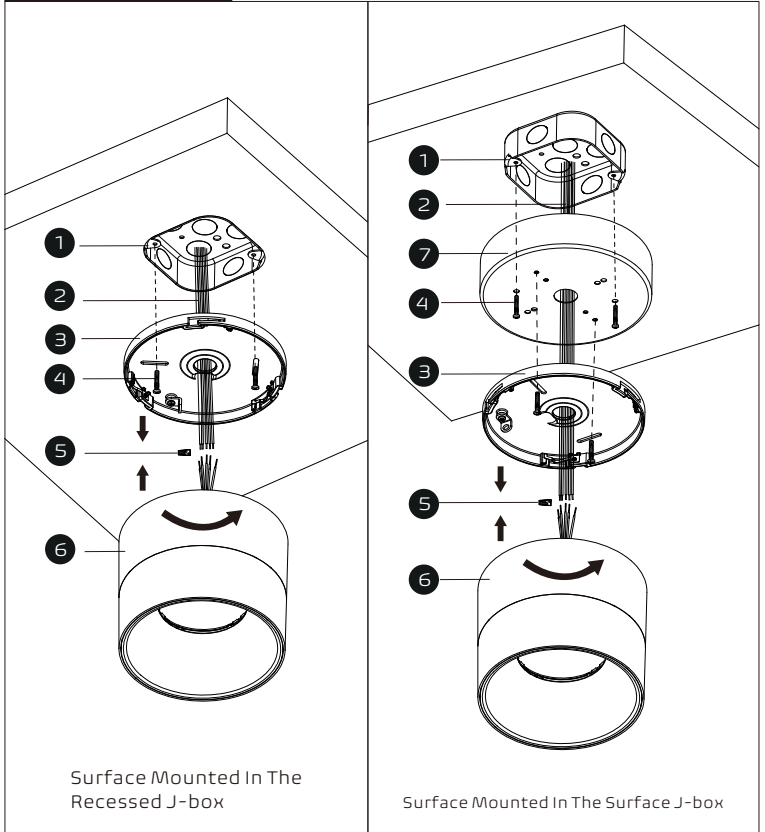

4" /6" /8" Cove

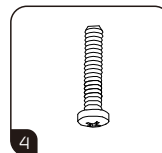

Screw KM4*22

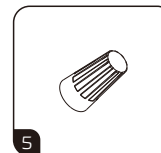

Wire Nut



4" /6" /8" Lamp



6" Canopy Power Feed

PARTS

- 1 4" Octagon Junction Box (By Others)
- 2 Power Cord (By Others)
- 3 4" /6" /8" Cove
- 4 Screw KM4*22
- 5 Wire Nut
- 6 4" /6" /8" lamp
- 7 6" Canopy Power Feed



RISK OF FIRE AND ELECTRICAL SHOCK. FIXTURE MUST BE INSTALLED BY A QUALIFIED ELECTRICIAN ONLY IN ACCORDANCE WITH NATIONAL, LOCAL BUILDING AND ELECTRICAL CODES. DISCONNECT POWER AT ELECTRICAL PANEL BEFORE SERVICING.

► 4" Pendant With Cable

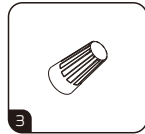
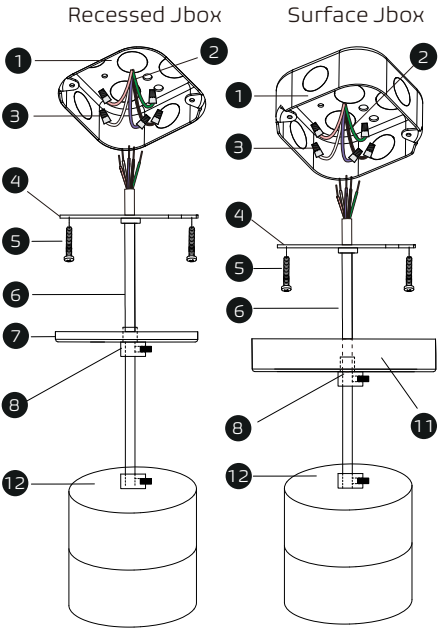

Wire Nut

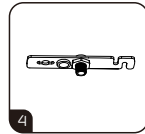

Junction Box Crossbar

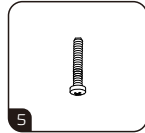

Screw PM4*22

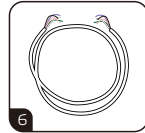

Power Cord

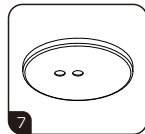

4" Canopy Power Feed

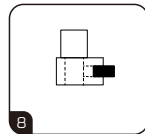

Cable Clip

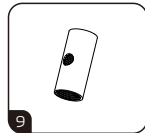

Cable Holder

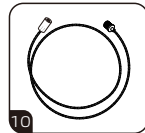

Aircraft Cable

► 6" And 8" Pendant With Cable

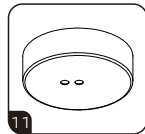
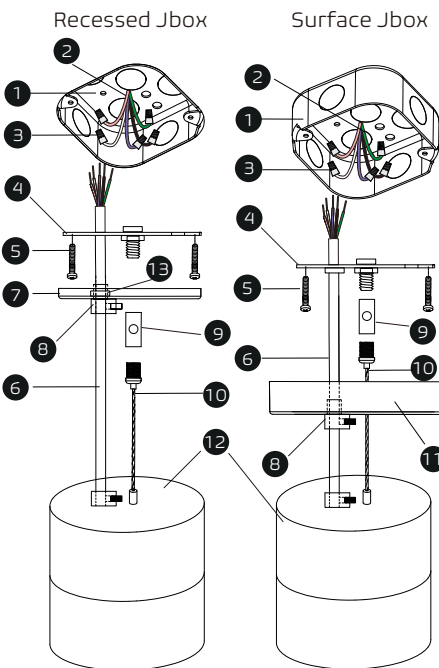

6" Canopy Power Feed

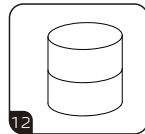

4" /6" /8" Lamp

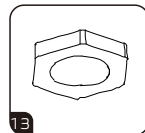

screw nut

► PARTS

- 1 4" Octagon Junction Box (By Others)
- 2 Power Cord (By Others)
- 3 Wire Nut
- 4 Junction Box Crossbar
- 5 Screw PM4*22
- 6 Power Cord
- 7 4" Canopy Power Feed
- 8 Cable Clip
- 9 Cable Holder
- 10 Aircraft Cable
- 11 6" Canopy Power Feed
- 12 4" /6" /8" Lamp
- 13 Screw nut

► Pendant With Stem

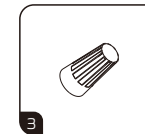
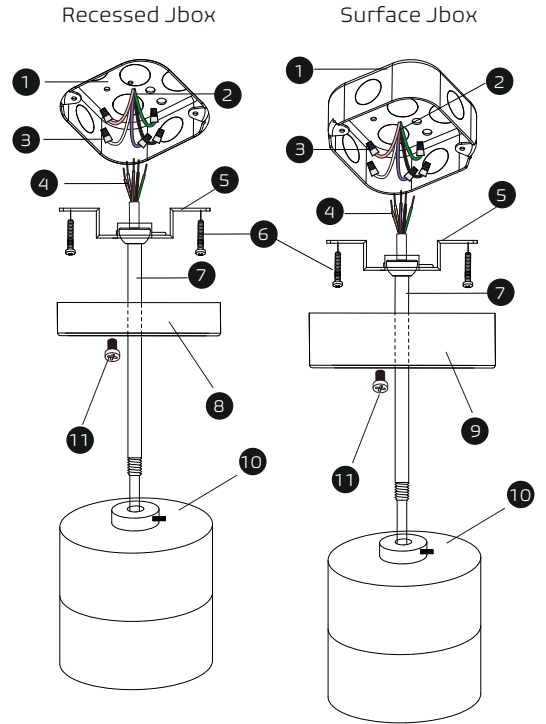

Wire Nut

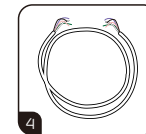

Power Cord

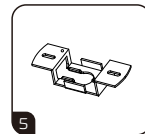

Junction Box Crossbar

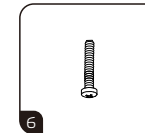

Screw PM4*22

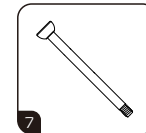

Stem Kits

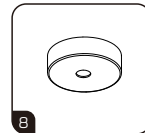

4" Stem Canopy Kits

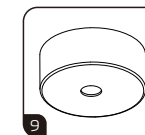

6" Stem Canopy Kits

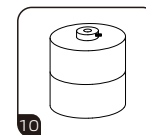

4" /6" /8" Lamp

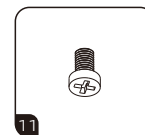

Screw PM3*5

► PARTS

- 1 4" Octagon Junction Box (By Others)
- 2 Power Cord (By Others)
- 3 Wire Nut
- 4 Power Cord
- 5 Junction Box Crossbar
- 6 Screw PM4*22
- 7 Stem Kits
- 8 4" Stem Canopy Kits
- 9 6" Stem Canopy Kits
- 10 4" /6" /8" Lamp
- 11 Screw PM3*5