

RECESSED FLANGE KIT

INSTALLATION INSTRUCTION DRY CEILING

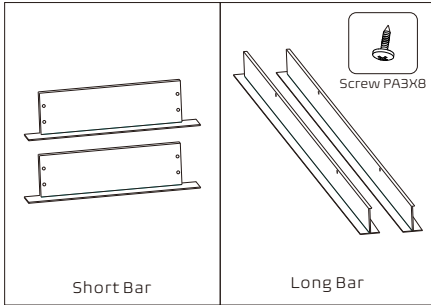

WARNING: Installation and servicing to be performed only by qualified personnel. If not qualified, consult an electrician. Risk of Electrical Shock! Disconnect power at fuse or circuit breaker before installing or servicing.



Short Bar

Long Bar

Size Of Luminaire	Ceiling Opening Size
L 2' X W 4"	L 24 3/4" X W 4 3/4"
L 2' X W 6"	L 24 3/4" X W 6 3/4"
L 2' X W 2'	L 24 3/4" X W 24 3/4"
L 4' X W 4"	L 48 3/4" X W 4 3/4"
L 4' X W 6"	L 48 3/4" X W 6 3/4"
L 4' X W 1'	L 48 3/4" X W 12 3/4"
L 4' X W 2'	L 48 3/4" X W 24 3/4"
L 8' X W 4"	L 96 3/4" X W 4 3/4"
L 8' X W 6"	L 96 3/4" X W 6 3/4"

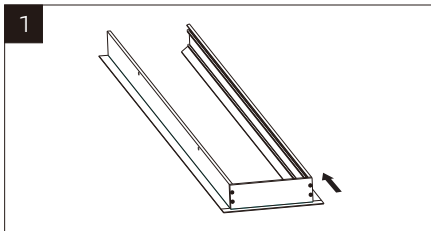

1
Join the 2pcs long bars and 1pc short bar together with screws.

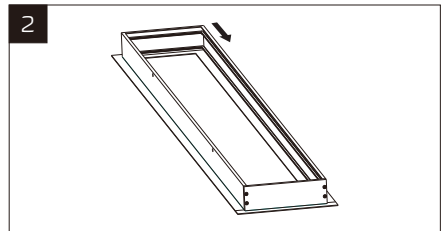

2
Then join these 2pcs long bars and another short bar together with screws.

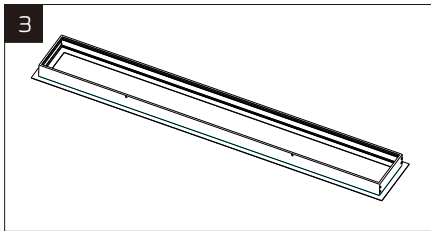

3
Assembly complete

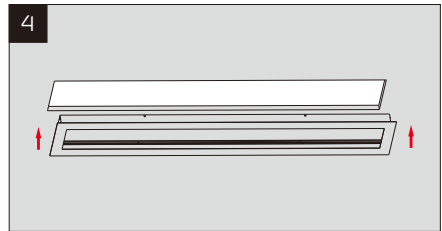

4
Embed this flange kit through the ceiling opening

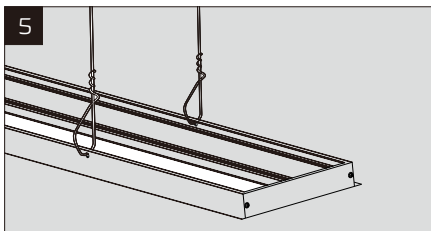

5
Fix the aircraft cable on the long bar

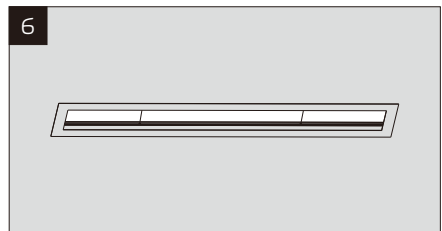

6
Suspend the flange kit to level with the ceiling, installation complete.