

# Zeta Slim 1.3" Linear

Architectural LED Luminaire







The LED luminaire market has become more competitive, we see many similar products, that only focus on price. We designed a lighting product that achieves innovation, versatility and affordability together, and it was named after the Greek letter Zeta, the shape of the letter Z resembles lightning.

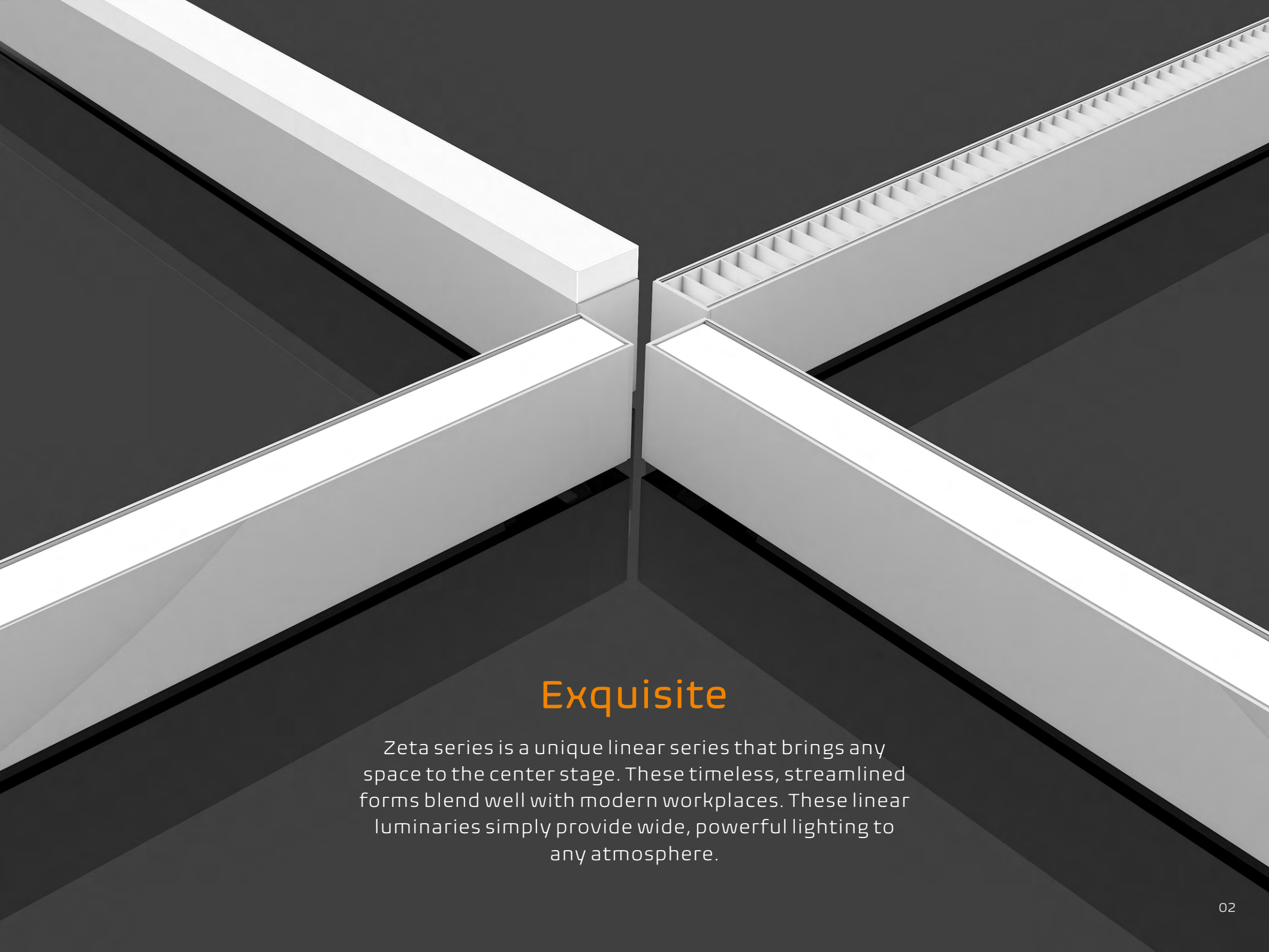

## Exquisite

Zeta series is a unique linear series that brings any space to the center stage. These timeless, streamlined forms blend well with modern workplaces. These linear luminaries simply provide wide, powerful lighting to any atmosphere.



Combining superior esthetics, quality performance and unparalleled versatility, Zeta offers new opportunities to capture the beauty and benefits of true lighting.

- 90+ CRI
- Wattage selectable 50%/75%/100%
- CCT adjustable 3000K/ 3500K/ 4000K
- Suspended, surface and wall mounted
- 25%up/75%down and 100% down lighting distributions options by DIP Switch
- Seamless continuous runs
- Custom pattern with optional joiners
- Available in diffuser, louver and convex
- 2ft, 4ft and 8ft lengths, up to 1200lm/ft

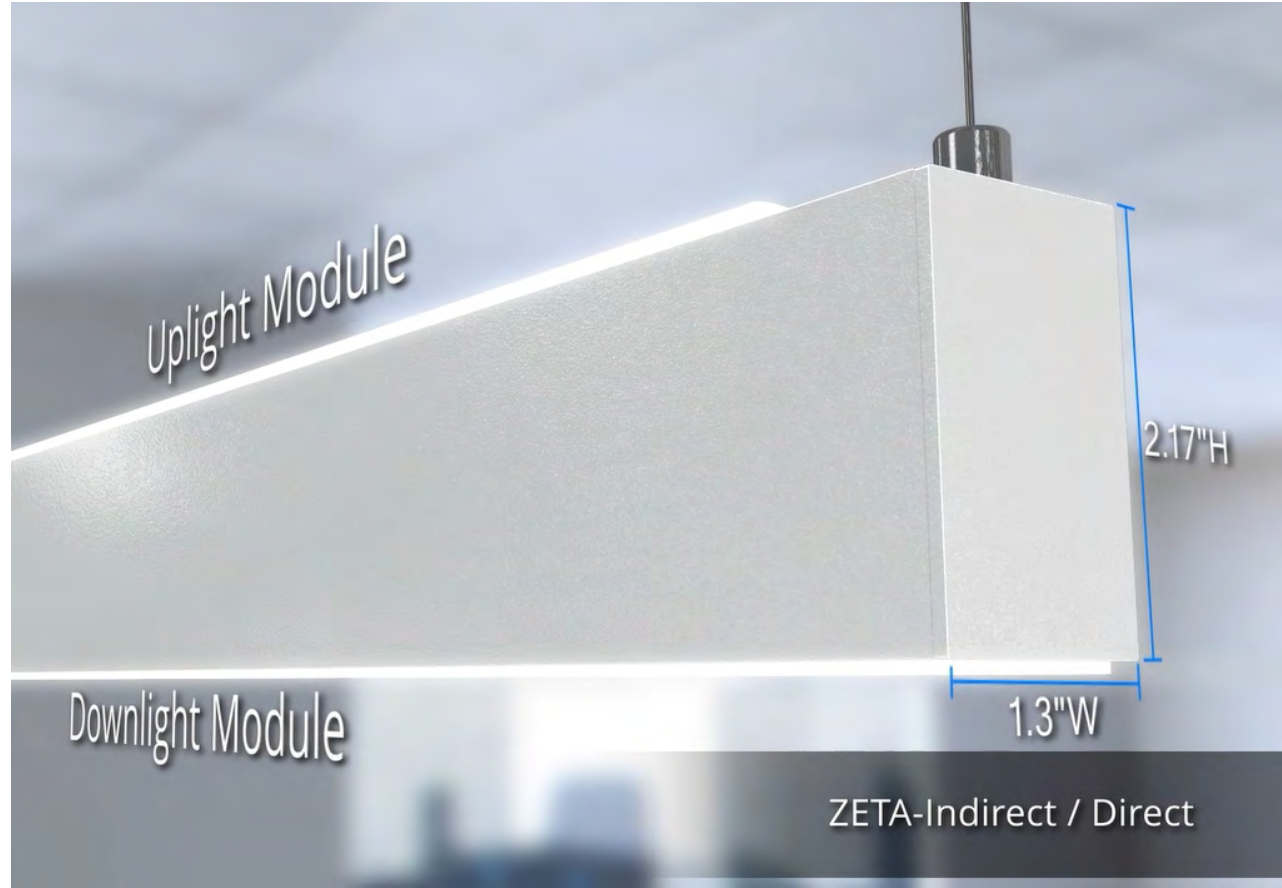

ZETA-Indirect / Direct

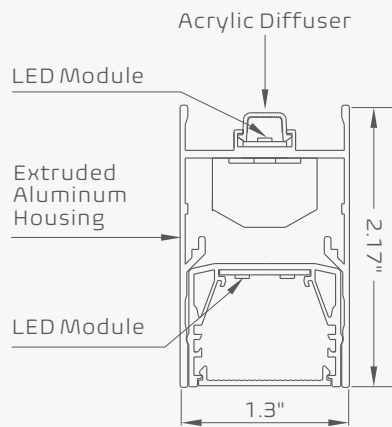

## Standard lengths for any applications

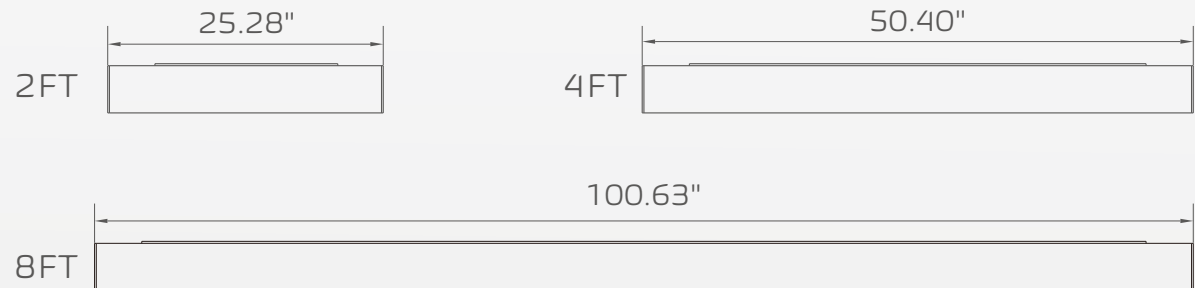

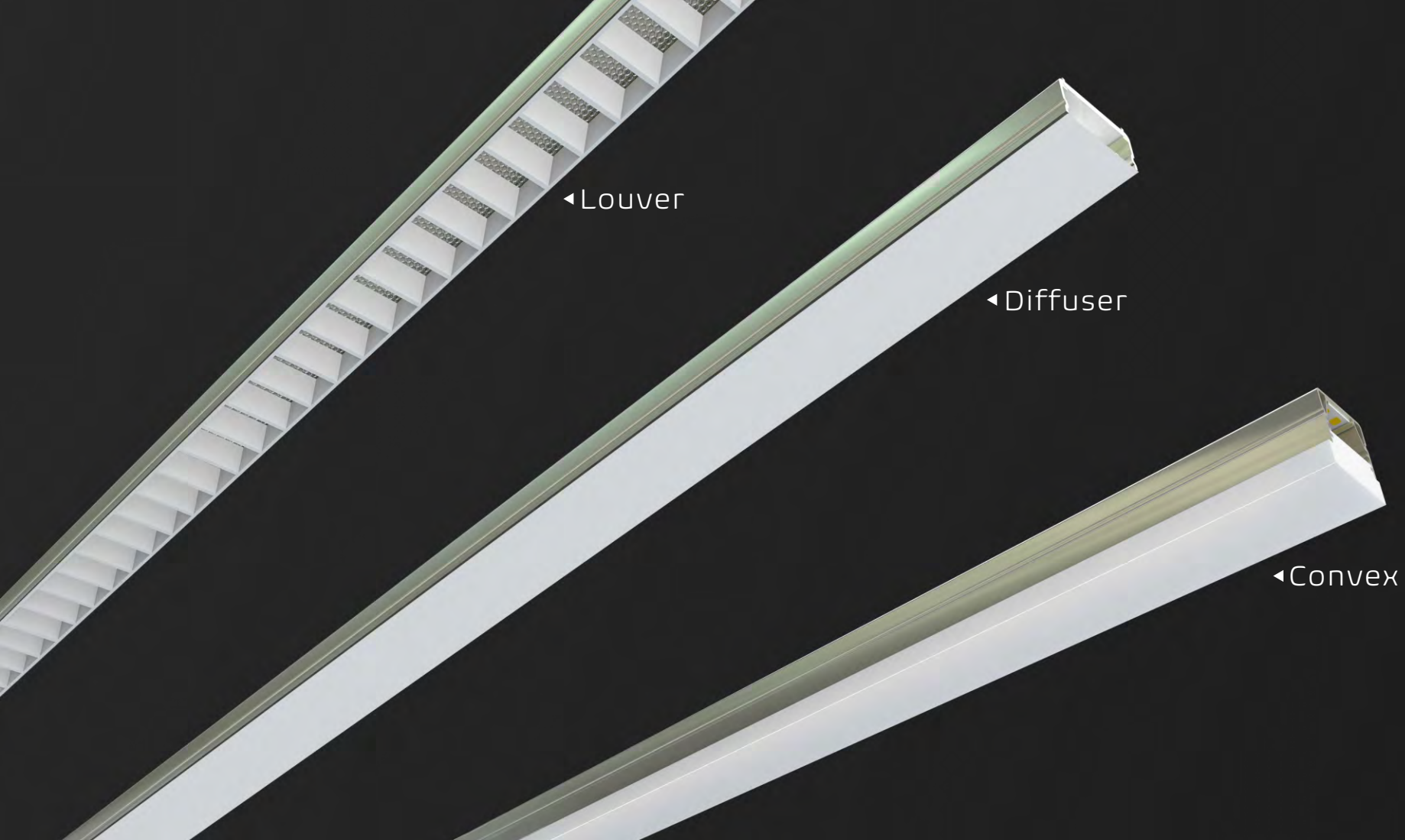

## Visual Comfort

Zeta offers a selection of professional lenses such as diffuser, louver and convex. Each of these lenses challenges the critical glare rating and elevate our entire architectural product line to a higher standard. These precise distributions can better decorate the space without any concern.

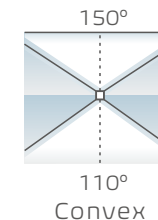
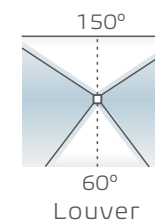
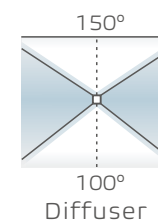





# Powerful

The Zeta Series can provide smooth direct or indirect lighting distribution, allowing for wider spacing between fixtures and better ceiling light uniformity.

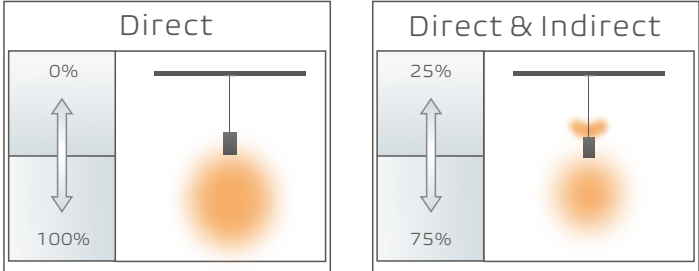

\*Adjust direct or direct & indirect by DIP Switch









## Versatile

Unleash lighting design flexibility with Zeta with different shapes and patterns, it adds fun factor into each room. These creations will let you suggest rhythm, communicate meaning and showcase element of life.



"—" pattern

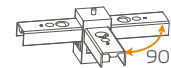

"T" pattern

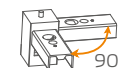

"L" pattern



"+" pattern

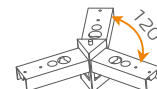

"Y" pattern

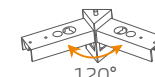

"V" pattern





# Open Area

Application Data

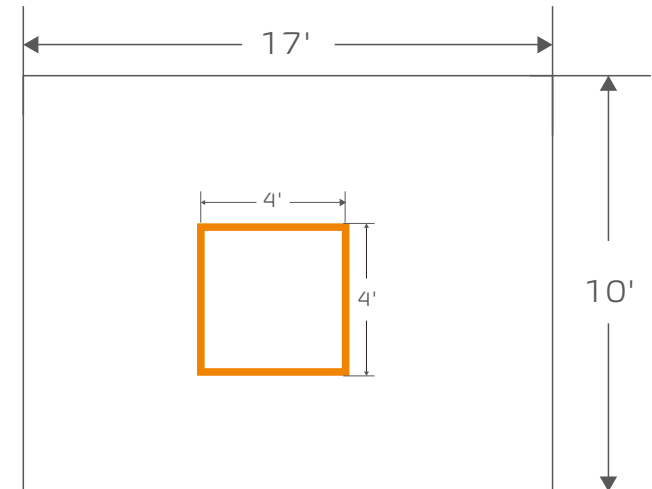

	<b>ZE4-ID40R</b>
Average Illumination	32 fc
Consumption(w/ft <sup>2</sup> )	0.39w/ft <sup>2</sup>

- ※ Product shown above
- 4000K
- Internal driver
- Diffuser

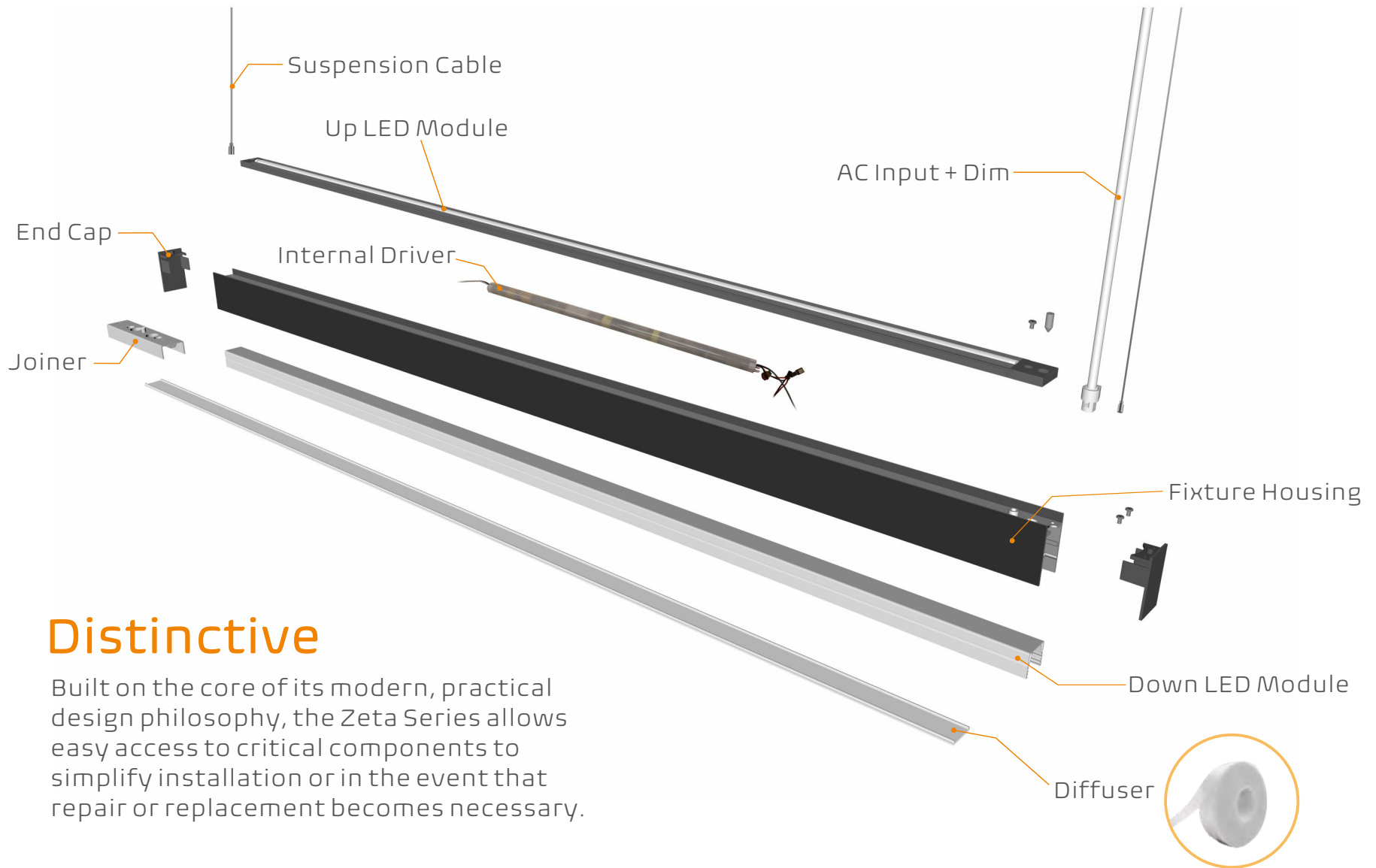

## Distinctive

Built on the core of its modern, practical design philosophy, the Zeta Series allows easy access to critical components to simplify installation or in the event that repair or replacement becomes necessary.

## Simple And Clean

Each Power Feed

- 120VAC: connections up to 40ft.
- 277VAC: connections up to 100ft.

### 42' Continuous Roll-out lens

Create clean, seamless runs that are quicker to install with this quality press-in acrylic lens that will not crinkle or bow.





## Mounting Options

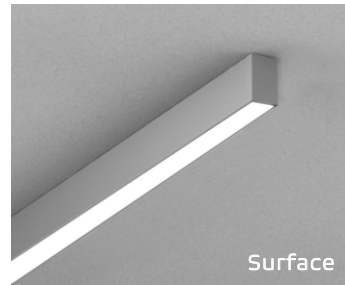
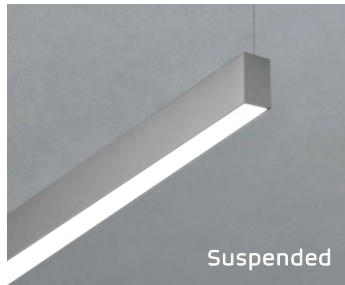





## SURFACE-HIGHLIGHT YOUR SPACE

It enables designers to mount the luminaire on the ceilings to enhance architectural styling which is attractive and easy to install with simplescrews or threaded studs which pass through the housing to fasten the luminaire in place. Ideal for locations with low ceilings.

## WALL MOUNT - DECOR YOUR SPACE

It is available in a wall mount design, with a sleek low-profile sensibility optimal for architectural lighting applications, ideal for corridors, stairwells, and more. These timeless, streamlined forms blend well with contemporary decors and modern workplaces.

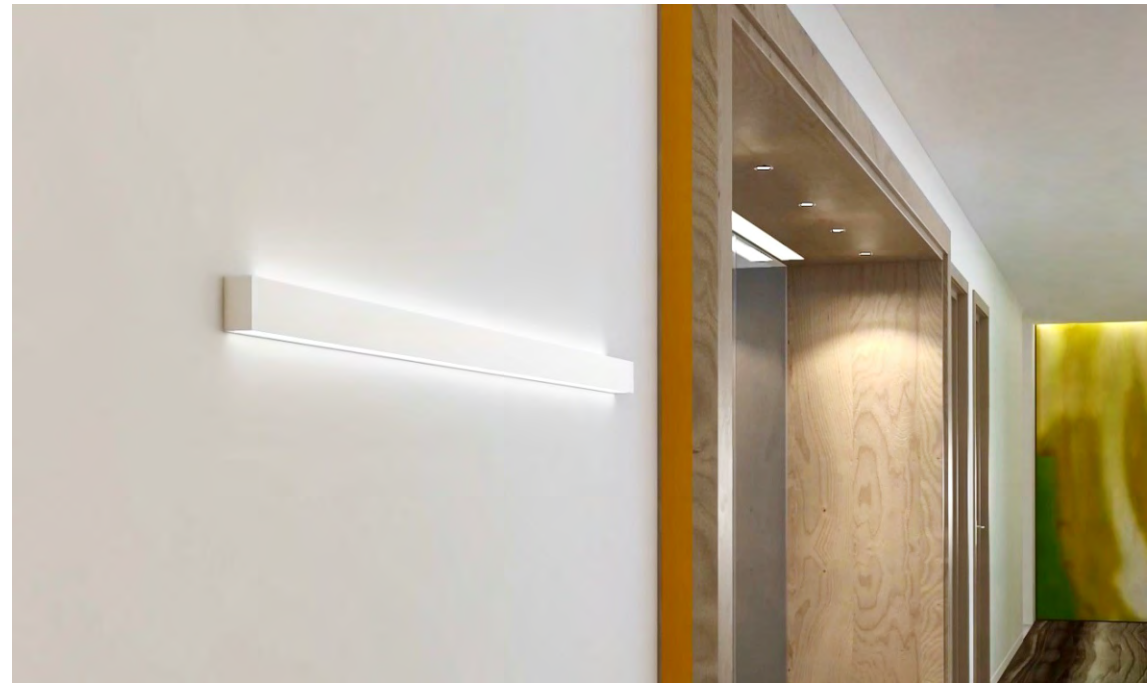





## American's architectural and commercial LED Lighting Enthusiast

Founded in 2008, OKT is known for quality commercial and architectural lighting in North America. We deliver better light you can see, experience and benefit from. At OKT Lighting, our teams are made up of dreamers and doers who are committed to making better lighting. We're not only focused on making solutions that last, but on redefining what's possible, from the lighting we engineer to the value we add.

## WE ARE YOUR RELIABLE PARTNER

We are your logistics hub. Our network covers entire North America.

- Shipping within 48 hours
- Without Stock Risk
- No Tariff Worries
- Live Inventory Access
- 24/7 Online Service
- Local Assembly
- Prompt RMA
- Local OEM
- Dropship

We are your marketing dept., visual marketing support is available.

- Data Sheet
- Sales Sheet
- Installation Sheet
- IES
- Revit Files
- HD Photos
- Video
- Sample Bags
- Professional Product Training

@OKT Lighting. All right reserved. Product design and development is an ongoing process by OKT Lighting. We reserve the right to change specifications. Contact OKT for the latest product information or visit [www.oktlighting.com](http://www.oktlighting.com) for more.