

# SCONCE WING

Pendant | Architectural LED Linear



Combining superior esthetics and quality performance, OKT Sconce Wing offers new opportunities to capture the beauty and benefits of architectural linear lighting. It offers wattage and CCT adjustable for scalability. The sleek profile is designed to blend into clean, minimalist architectural spaces. Reaching 88 lumen / watt with 90+ CRI, we strive to challenge the highest visual comfort standard by offering ultra-thin semi-transparent vertical optics. Easy install in the field which is perfect for applications that include open offices, hospital, anywhere you want to make a statement. This innovative produce design brings both performance and aesthetics to any design applications.

## Feature

- Ultra-thin semi-transparent optics
- 48" length, shallow depth 2"
- Maximum 40w, wattage selectable (50%/75%/100%)
- Up to 88lm/w, 90+ CRI
- CCT adjustable from 3000K, 3500K, 4000K
- 1-10v dim, 10% standard, 1% optional
- Compatible for dry ceiling and drop ceiling
- Continuous runs



## PERFORMANCE

Length	Lumen Package		
	High	Medium	Low
48"	3500LM, 40W	2650LM, 30W	1750LM, 20W

All efficacy is ±5% base on 3000K. Check the IES file to gain the accurate data.

©OKT Lighting. All right reserved. Product design and development is an ongoing process by OKT Lighting. We reserve the right to change specifications. Contact OKT for the latest product information or visit [www.oktlighting.com](http://www.oktlighting.com) for more.

# SCONCE WING

Pendant | Architectural LED Linear



## STRUCTURE

### ► Light Guide

Ultra-thin semi-transparent light guide made of PMMA material, allows distribution of controlled light in all 3-dimensions to put light on both vertical and horizontal planes within the space.

### ► Construction

Housing: Extruded aluminum  
End Cap: Die cast aluminum  
Smooth Lens: Uniform acrylic lens  
Finish: Powder coat white or custom\*

### ► Electrical

**Min Internal LED Driver** It is powered by Class 2 high efficiency LED driver, with a standard 1-10V dimming that works with many types of controls. Continuous dims to 10% (standard), 1% (optional) . Tested Dimmers: Lutron® Diva-Dvtv, Leviton® IP-710-DL.

**THD** <20%  
**Power Factor** >0.9  
**Input Voltage** Standard electronic drivers are UL recognized and available for 120-347AC input voltage.

### ► LED System

**CRI** Minimum 90 color rendering index  
**CCT** CCT adjustable from 3000K, 3500K, 4000K with a great color consistency.

**LED** Minimum 50,000h with 87.8% of lumen maintenance in 25°C ambient temperature, in compliance with IES LM-80 testing measurements.

**Thermal Management Environment** Aluminum housing acting as the heat sink to maximize life.  
damp rated for ambient operating temperature of -20°C to +40°C (-4° to +104°F)

### ► Mounting

- Pendant-Dry ceiling or T-Grid ceiling compatible. Cable lengths of 5ft is standard, 12ft or others are available.
- Continue runs per power feed: Up to 10pcs in 120V AC, 20pcs in 277V AC and 347V AC.

### ► Approvals

- cULus listed-Pending
- Suitable for damp locations
- Designed for indoor use only
- 5 years limited warranty

### ► Optional Function

**Emergency option** Optional OKT high voltage 8W emergency LED driver (OKT Model#EM-H08170-LBF) can be provided. When AC power fails, it immediately switches to the emergency mode, operating for lighting up to 120 minutes. When AC power is restored, it automatically returns to the charging mode which meets critical life-safety lighting requirements. For more info, please visit our website or contact sales.



Emergency Lumen Output:

**FIXTURE EFFICACY**      **OUTPUT POWER 8W**

88lm/w

3520 Lumens

## PRODUCT ORDERING GUIDE

### Sample

WS-WGA-P TW 48

WS-WGA P TW 48

### 1. Base Model

WS-WGA      Sconce Wing Series

### 2. Mounting

P      Pendant

### 3. CCT

TW      CCT Adjustable 3000K/3500K/4000K

### 4. Length

48      48"

## OPTIONAL ORDERING GUIDE

### Ceiling Type

- Dry Wall (Mount to J-box)
- Drop Ceiling Clips (Suitable for 9/16" and 15/16" Flat Ceiling)
- Drop Ceiling Clips (Suitable for 9/16" Slot Ceiling)
- Drop Ceiling Clips (Suitable for 15/16" Slot Ceiling) \*

### Optional Function

- Emergency \*

\*Additional cost and/or lead time on customized fixtures may apply. Some fixtures require an MOQ. Please contact your sales rep for more information.

## DIMENSIONS

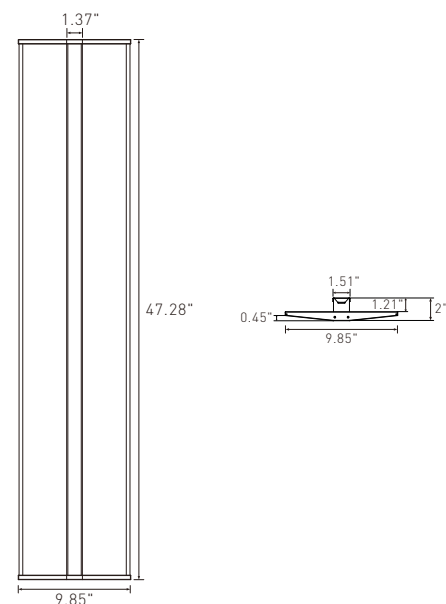

# SCONCE WING

Pendant | Architectural LED Linear



## MOUNTING

### Canopy Style



1.6" Round  
(Non Power Feed)



4.5" Round  
(Power Feed)



4.5" Round With  
Emergency Driver  
(Non Power Feed)



5.8" Round With  
Occupancy Sensor  
(Power Feed)



1.6" Square  
(Non Power Feed)



4.5" Square  
(Power Feed)



4.5" Square With  
Emergency Driver  
(Non Power Feed)



### Dry Ceiling / Off Grid

"Various Hard Ceilings"  
(Mount to J-box)

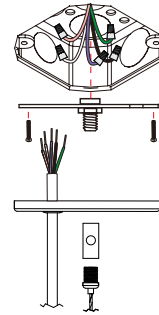
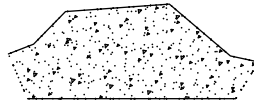

### Drop Ceiling / On Grid

Suspending the luminaire in the T-grid.  
Compatible for various T-grid, including  
9/16" Flat, 9/16" Slot, 15/16" Flat.

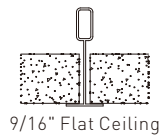

9/16" Flat Ceiling

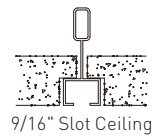

9/16" Slot Ceiling

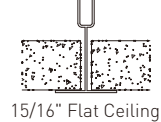

15/16" Flat Ceiling

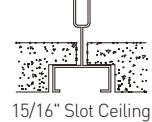

15/16" Slot Ceiling

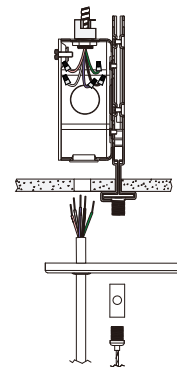

\*Please see the installation instruction for more details.

# SCONCE WING

Pendant | Architectural LED Linear



## DISTRIBUTION DIAGRAM

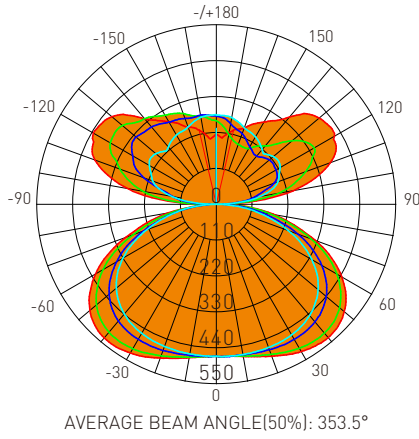

Lumens: 3613.7 Lm  
Watts: 37.99 W  
LPW: 95.12 Lm/W  
CCT: 3000K

UNIT: cd  
 - C0/180, 333.8°  
 - C30/210, 360.0°  
 - C60/240, 360.0°  
 - C90/270, 360.0°

### Zonal Flux Diagram

τ	C0	C45	C90	C135	C180
10	474.0	469.9	467.6	474.6	477.4
20	495.7	482.2	467.1	487.7	501.5
30	521.2	493.8	462.3	497.2	526.3
40	533.3	494.1	444.9	490.9	534.7
50	511.9	468.3	407.2	454.5	505.8
60	443.3	402.2	337.4	377.1	427.6
70	322.2	290.4	234.4	253.5	294.8
80	177.1	153.3	116.4	121.2	147.9
90	35.38	28.83	1.721	39.10	50.46
100	237.9	147.0	132.8	174.8	274.2
110	371.2	225.6	200.9	253.6	395.8
120	418.6	259.7	225.7	330.1	435.3
130	411.5	235.9	228.4	345.4	418.1
140	349.3	206.6	218.7	324.6	342.3
150	290.9	192.1	239.7	301.9	291.9
160	249.1	215.9	250.6	288.7	251.0
170	222.8	241.0	269.9	277.5	221.7
180	215.4	266.9	273.4	267.9	215.4
DEG	LUMINOUS INTENSITY:cd				

### Zonal Lumens

τ	φ total
0-10	44.78
10-20	180.2
20-30	406.4
30-40	715.9
40-50	1084
50-60	1465
60-70	1794
70-80	2007
80-90	2082
90-100	2192
100-110	2492
110-120	2720
120-130	3004
130-140	3232
140-150	3401
150-160	3519
160-170	3589
170-180	3614
	UNIT: lm

### Luminance cd/(m2)

G(DEG)	C0/180	C90/270
85	4237	2617
80	4407	2885
75	4122	2904
70	4071	2951
65	3989	2956
60	3831	2905
55	3653	2831
50	3441	2727
45	3228	2613