

OKT



OUR PHILOSOPHY

We believe in light as an extension of every surface, every structure – enriching everyday experiences through light. Every piece of design and technology we engineer, we take the complexity out of lighting by creating products to transform the lighting experience.

THE OKT DIFFERENCE

We focus on North America over 10 years

OKT is trusted by known brands in North America. We appreciate these loyalty, and together, we can make a difference.

We focus on innovation through product vitality

We place visual comfort, flexibility and affordability as the focal points in product development.

We concern intellectual property

T-grid linear series, indirect troffer series, vertical linear series. Patent issued, more on the way.

We concern stocking issues

Modular design, CCT & wattage adjustable, replaceable driver are equipped in OKT product line.

We are your logistics hub and warehouse

We provide local 24/7 online service, local RMA, local OEM, local assembly, drop ship.



WHO WE ARE?

OKT LIGHTING



WE ARE A GROUP OF LIGHTING ENTHUSIAST

OKT lighting, a group of passionate lighting enthusiast that make things right, began over 15 years ago and known for quality commercial and architectural lighting in North America which became the designers' choice for professional grade.

WE MAKE BETTER LIGHTING

At OKT Lighting, our teams are made up of dreamers and doers who are committed to making better lighting. We're not only focus on making solutions that last, but on redefining what's possible, from the lighting we engineer to the value we add.

WE FOCUS ON INNOVATION

OKT continues to advance R&D throughout all challenges. We are able to provide fast & reliable ODM service, and develop technologies that enables more projects.

- More tailored lighting designed with modular
- 90+CRI is now a new standard
- CCT & Wattage adjustable now standard
- Smart lighting control option
- More 1% dimming products
- Replaceable driver for better maintaining

WE ARE ALWAYS MOVING FORWARD

Today, OKT lighting continues to represent visual appeal and efficient performance, allowing you to maximize the impact of light and get the most out of indoor environments.



Quickship

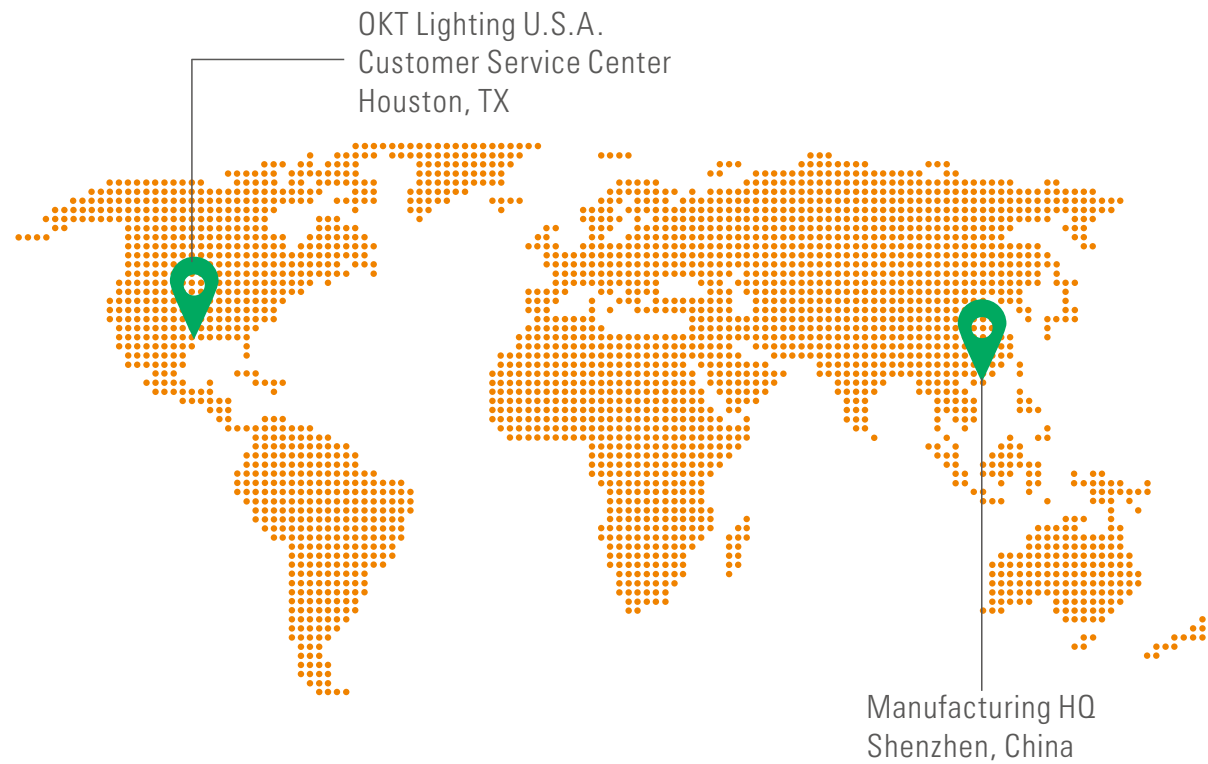

READY TO GO – DELIVERED WITHIN 5 BUSINESS DAYS

Save time and improve efficiencies by consolidating your stock purchases with us! Our ready to go portfolio makes it easy to find what you need. Our products are easy to check inventory through oktusa.com, easy to install with minimal steps, and competitively priced to meet the demands of budget conscious projects focused on cost and energy.

WE ARE YOUR LOGISTICS HUB. OUR NETWORK COVERS ENTIRE NORTH AMERICA.

- Shipping within 48 hours
- Without Stock Risk
- No Tariff Worries
- Live Inventory Access
- 24/7 Online Service
- Local Assembly*
- Prompt RMA
- Local OEM
- Dropship

At a glance

≤ 5 Days

Delivered within the North America. *
Our distribution network now covers entire North America with UPS/FEDEX services and/or LTL freight.

500+

SKUs in stock
The most complete stock offerings in the architectural and commercial lighting.

24/7

Customer Service *
We strictly enforce the perfect pre-sale, sale and after-sale service, fully make your time saving.



INNOVATION NEVER STOPS AT OKT

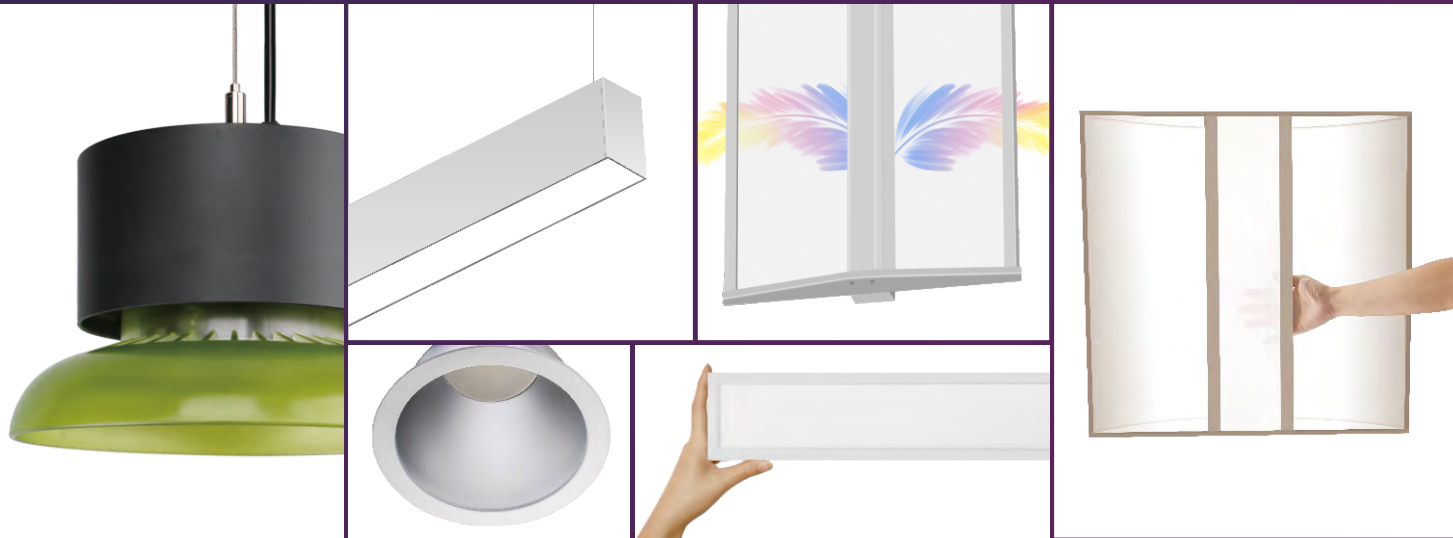

1% DIMMING

OKT continues to advance R & D throughout all challenges. Since its innovation, Dim to 1% option has offered that can be better serving our clients with increased flexibility and healthier environments expressed uniquely with each new project. The above are a selection of OKT product family with 1% dimming option that enables more projects.

Always Moving Forward

2023 New Released

Cylinder - Endless Design Possibilities

OKT's cylinder would greatly help maintain consistency and create possibilities in the whole commercial area which make light modular with multiple mounting ways, interchangeable optics, and high visual comfort reflectors. This form factor is now available in pendant and surface mount configurations which offers a beautiful, decorative solution with beautifully anodized white, black finishes while delivering high performance.



ZETA Family - The Most Completed

Combining superior esthetics, quality performance and unparalleled versatility, Zeta offers new opportunities to capture the beauty and benefits of true lighting. This ZETA solution does it all, in a system with a small scale extruded profile that not only provides straight lines but also well-controlled ambient lighting. It's an excellent choice for pendant, surface, recessed and wall mount.

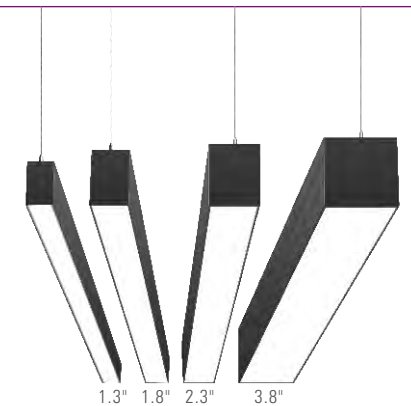
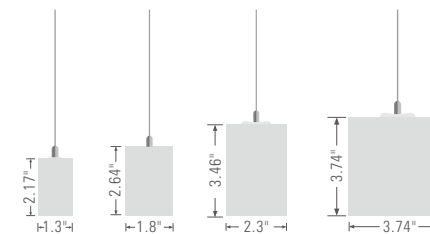

Sconce Wing - Lighting Aesthetic

Sconce Wing brings a new dimension to architectural wall lighting. It provides low-level lighting when daytime to evening. Additionally, It can be wall or surface mounted adding a layer of light on the walls that feels less institutional, to soften facility ambiance and enable interior design cohesiveness. This innovative design brings both performance and aesthetics to any design applications.



Product Guide

Recessed Lighting Solutions

T-Grid Linear 14-27

Let the ceiling tile shine with integrated lighting, we made it easy for you to specify and maintain the crisp. TB series is compatible with known- industry 's standard size ceiling tiles.



TB Series

Floating Air Troffer 32-35

It is an innovative LED luminaire designed to deliver a modern aesthetic, showing a nearly transparent luminaire when off and excellent uniformity and efficiency when on.



TT Series

Floating Curved Troffer 36-41

Designed to deliver uniform and soft illumination with back-lit technology, it features a compact yet sturdy aluminum construction designed to blend into modern architectural spaces.



TR Series



Deep Regressed Downlight 44-51

We've made every engine to work seamlessly with the all trims, making it truly modular. It is the ideal way to retrofit incandescent, CFL and HID to LED into existing recessed housing or frame-in kit.



CES Series

J-Box Downlights 52-59

It is a breakthrough addition to the downlight family which is built with an integral junction box that eliminates the need for a traditional recessed housing and mounts directly into ceiling in the new construction.



CP Series

Copa 3" Downlights 60-65

Thanks to a unique low profile and small aperture design, we offer highly customizable options for trim color, shape and mounting accessory.



CP3 Series

Slim Recessed Linear 66-71

Designed for grid ceiling, features popular 4", 6" width and length up to 8' with external driver; Embrace the grid that conceals gridlines while blending into the ceiling.



LR Series

ZETA 2.3" Recessed Linear 72-83

Sleek and simple, thin lines of light integrated with architecture for maximum impact and design flexibility. It is the perfect blend of lighting performance and timeless aesthetic.



ZETA Series

Suspended Lighting Solutions

ZETA Linear Family 86-109

Combining superior esthetics, quality performance and unparalleled versatility, Zeta offers the most complete possibility to capture the beauty and benefits of true lighting.

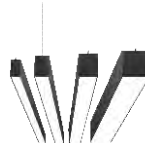

ZETA Series

META Linear Meta Up/Down Linear 112-119

Suspended from the ceiling, this strikingly beautiful luminaire combines brilliant aesthetics with space-filling light.



DP Series

Meta 2'x2' Linear 120-123

It delivers an aesthetic, stylish architectural solution which creates stunning forms only 1.5" high.

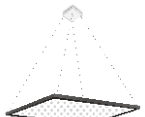

UP Series

Meta Vertical 124-133

It is integrated with ultra-thin semi-transparent vertical optics, precisely controlled optimal direct and indirect distributions.



LV Series

Meta Surface - Pendant 134-137

With three mounting options built inhouse, it makes it easy to get the light where you need it with offering new opportunities to capture the beauty and benefits of true lighting.



LV4 Series

Suspended Lighting Solutions

Cylinder 140-155

We offer numerous cylinder lighting options that complement our suspended and surface lighting platform, while providing a consistent aesthetic.

Cylinder Series



Surface Lighting Solutions

Sconce Wing 158-165

It can be wall or surface mounted, adding a layer of light on the walls that feels less institutional, to soften facility ambiance and enable interior design cohesiveness.



WS Series

Meta Surface 166-171

It enables designers to mount the luminaires on walls and ceilings to enhance architectural styling or add a unique flair to the interior design of a space.



LV4 Series

Surface Mount Linear 172-175

The bold, sleek design of the LS is aesthetically pleasing to any space. It comes with surface mount and recessed options with internal driver.



LS Series

Flush Mounted Panel 176-179

The unique internal driver makes it only 0.68" thickness. Only 0.12" gap between the panel and the dry ceiling for surface mounted installation.



FS Series

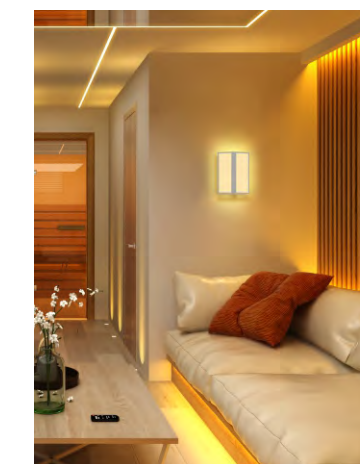

Emergency Lighting Solutions

LED Emergency Drivers 181-191









OKT offers UL Listed, field-installable, emergency LED drivers. All of OKT LED emergency driver portfolio is UL listed for installation in the field.



EM Series

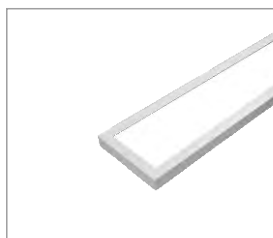

Recessed Lighting Solutions

 <p>T-Grid LED Linear TB Series</p> <p>14-27</p>	 <p>Floating Air Troffer TT Series</p> <p>32-35</p>	 <p>Floating Curved Troffer TR Series</p> <p>36-41</p>
 <p>Slim Recessed Linear LR Series</p> <p>66-71</p>	 <p>Zeta 2.3" Recessed ZE Series</p> <p>72-83</p>	 <p>Deep Regressed Downlight CES Series</p> <p>44-51</p>
 <p>J-Box Downlight CPS Series</p> <p>52-59</p>	 <p>Copa 3" Downlight CP3 Series</p> <p>60-65</p>	

T-Grid LED Linear



We Believe in Simplicity = Beauty

Under a suspended ceiling construction, imagine a simple grid lighting system can save labor cost and reduce the building waste, but also show the characteristics of your commercial space. Let the ceiling tile shine with integrated lighting, we made it easy for you to specify and maintain the crisp. TB series is compatible with known industry's standard size ceiling tiles, whether it's 9/16" or 15/16.

—
US Patent 10125934

—
DLC Standard, Up to 130lm/w

—
Low Profile

—
Easy Installation



Modular Design

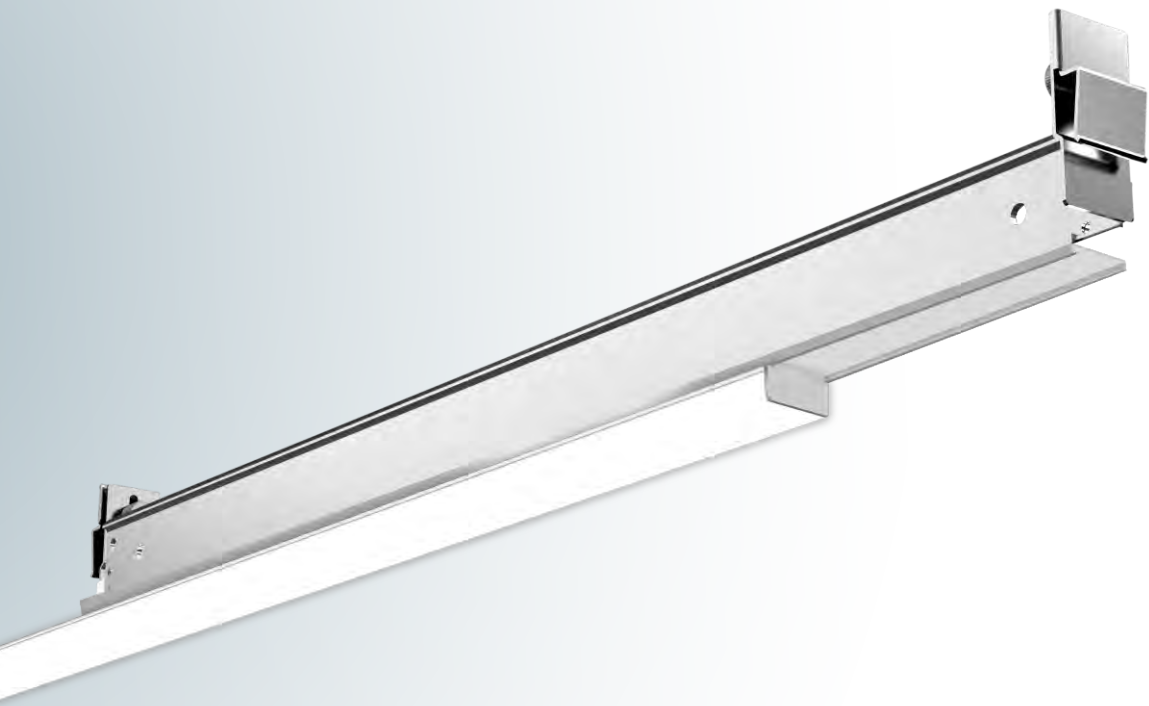

Innovative Separable Design

The innovative separable design of led module and T-Grid bracket makes it more flexible. One T-grid bracket allows for seamless integration of multiple led modules with different CCT or types with easy and tool free installation. What's more? Built on the core of its modern, practical design philosophy, the TB series allow easy access to repair or replacement of different CCT or lens becomes necessary.

— Connect LED module and bracket in a fast way

— Free to replace the LED module

— Ease replacement

Lens Challenge

It is available in 4 professional distributions. The TB series is certain to meet the most stringent of application requirements. This innovative produce design brings both performance and aesthetics to any design applications.



Milky Diffuser

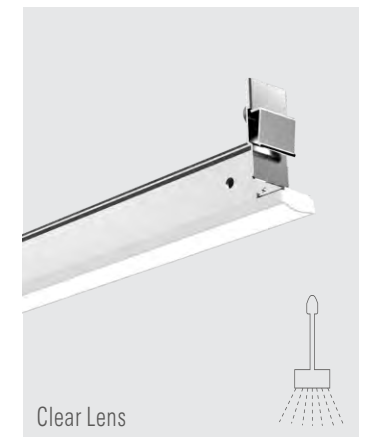
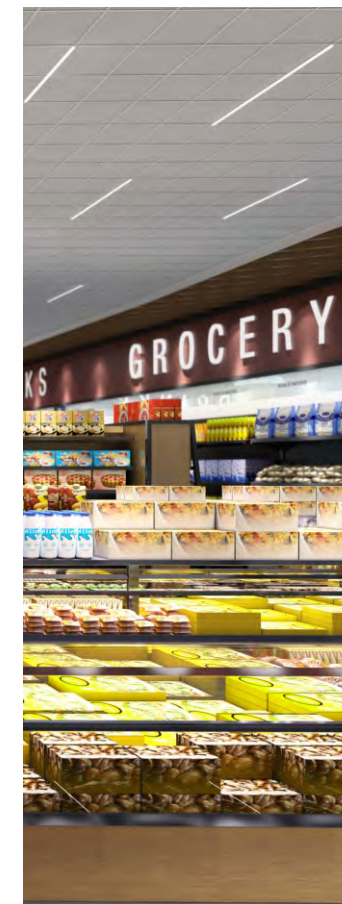

Clear Lens



Micro Reflector

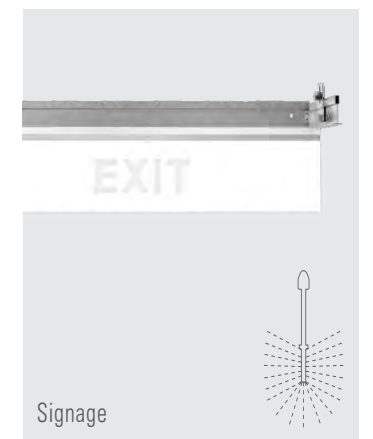

Signage

Almost Integrated To The T-grid Ceiling
Slim Profile 0.48" Thickness



Truly Universal Compatibility

It is a new generation green lighting solution that integrated into T-Grid suspended ceilings, allowing to be fully and seamlessly integrated into 9/16" flat, 9/16" slot, 9/16" interlude or 15/16" flat T-grid. It can replace selected cross tees of the suspended grid ceiling system where light is desired.



T-Grids Ceiling Compatibility

9/16" Flat

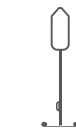

Suprafine® XL

9/16" Interlude

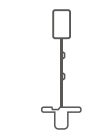

Interlude® XL

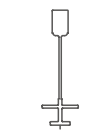

Sonata® XL

9/16" Slot



Silhouette® 1/4" XL

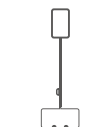

Silhouette® 1/8" XL

15/16" Flat

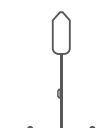

Prelude® XL

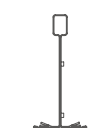

Clean Room

Note: Suprafine®, Silhouette®, Interlude®, Sonata®, Prelude®, are trademarks of Armstrong World Industries (AWI) company.

Flexible Lighting Solutions

No Application Is Out of Reach

T-Grid LED can be installed in many configurations by replacing any of the cross tees between the main runners of the suspended grid ceiling system assembly, providing a flexible general lighting solution for commercial and institutional environments such as offices, classrooms, retail and public space.

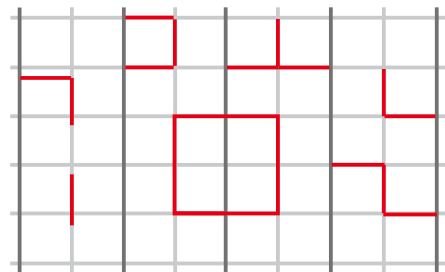

- Examples of configurations
- Possible positions for T-grid LED light modules
- One-piece main runner cannot be replaced



Architect Friendly

Custom Configuration

Considering different dimension and functions of a room, it is free to create compelling spaces, and your space no longer has to be restricted to a single pattern on the ceiling. Custom pattern such as L, T, +, □ etc.

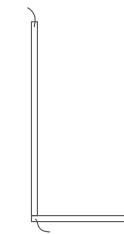

Shape: L	
Qty	Parts
1	2' Linear Light
1	4' Linear Light

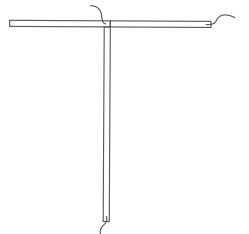

Shape: T	
Qty	Parts
2	2' Linear Light
1	4' Linear Light

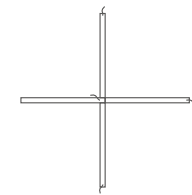

Shape: +	
Qty	Parts
4	2' Linear Light

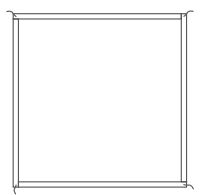

Shape: □	
Qty	Parts
4	4' Linear Light

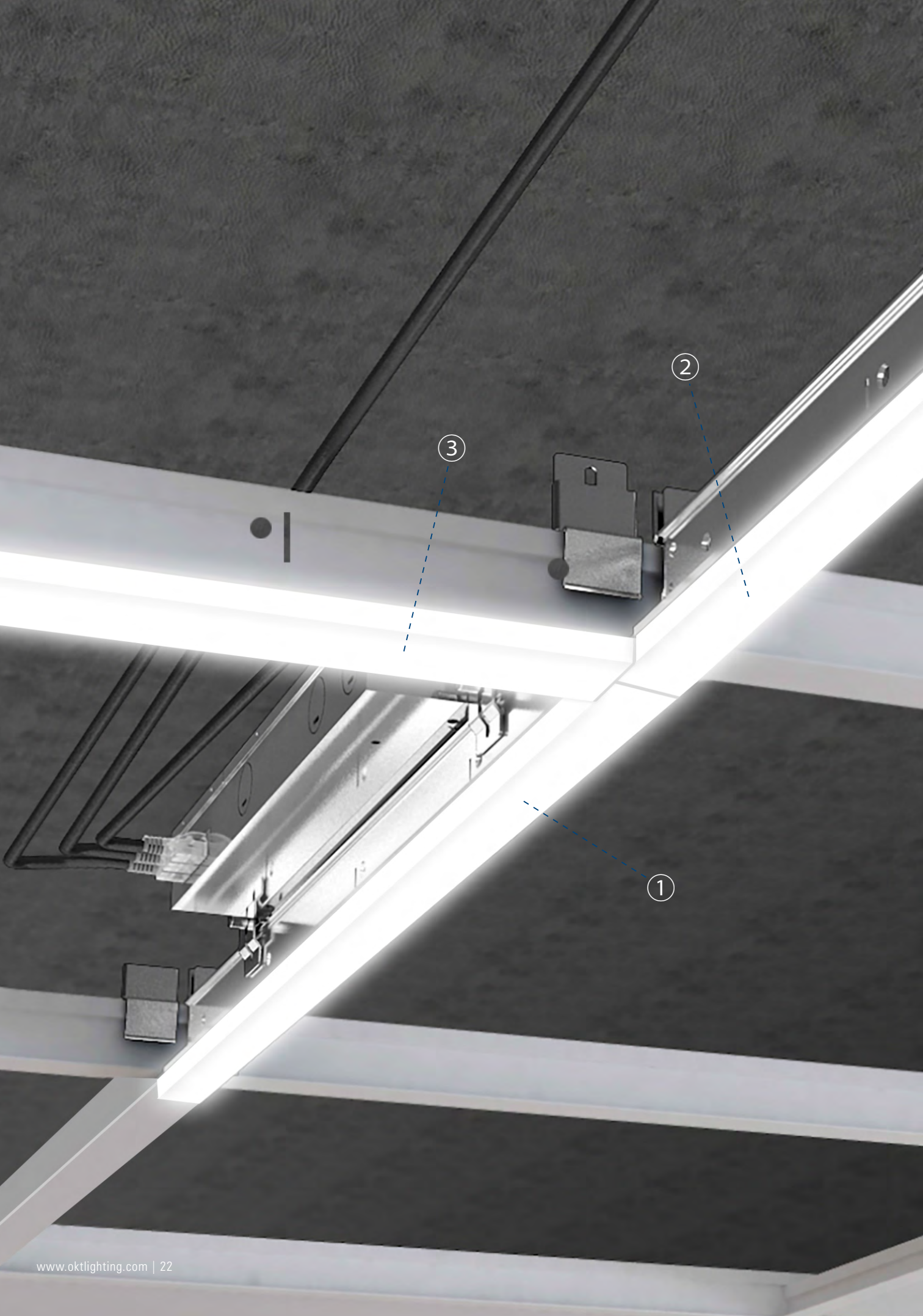

RJ45 terminal to make easy installation and safe wiring

RJ45 Terminal

Easy Wiring

Remote LED Driver

Brilliant design and intuitive engineering fearlessly combine to deliver unprecedented performance. TB series' striking contrast of effortless style and urban edginess makes a distinct statement in any suspending ceiling space. Max distance from fixtures to power supply is 8 feet with 24 AWG cable.

- It can be parallel connected up to 6ft (2' fixture) and 12ft (4' fixture) max per power supply.
- RJ45 terminal make easy installation and safe wiring.

— Connector Option









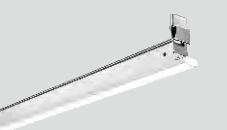

— Emergency Option

— CCEA Option

— Plenum Rated Cable Option

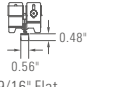
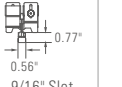
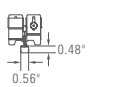
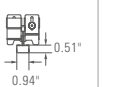

Specification-grade

				
Beam Angle	 128°	 70° 90°	 85°	 128°
Grid Type	 0.48" / 0.56" 9/16" Flat  0.77" / 0.56" 9/16" Slot  0.48" / 0.56" 9/16" Interlude  0.51" / 0.94" 15/16" Flat	 0.48" / 0.96" 15/16"	 0.46" / 0.95" 15/16"	 0.57" / 4.78" 9/16"
Custom Pattern	YES	YES	N/A	N/A
Lengths Wattage	2' 10W 4' 20W	2' 10W 4' 20W	2' 10W 4' 20W	2' 10W 4' 20W
Efficacy	600 lm/ft 115 lm/w	650 lm/ft 130 lm/w	550 lm/ft 110 lm/w	650 lm/ft 130 lm/w
DLC CCT Options	3000K/3500K/ 4000K/5000K	N/A	N/A	N/A
Finish	Anodised Silver			
Driver	Remote Driver (1 for 3 lights), 110-277VAC standard			
Dimming	1-10V, 10% dimming			
CRI	80+			
Emergency Option	Emergency Option (OKT Model#EM-H08170-LBF)			
Optional	CCEA Option Connector Option Plenum Rated Cable Option			
Certificate	US Patent, UL Listed, Damp Rated, IC Rated, DLC Qualification(Only for 9/16" Flat, 15/16" Flat diffuser)			
QuickShip	9/16" Flat 9/16" Slot 15/16" Flat	N/A	N/A	N/A



Dimension

9/16" Flat

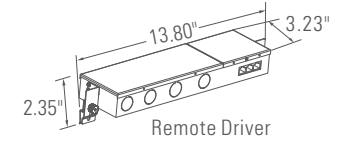
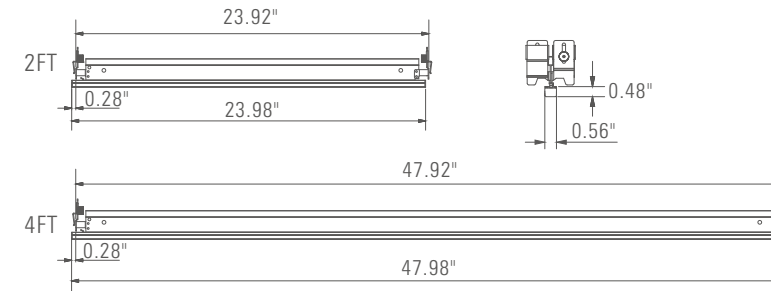

9/16" Slot

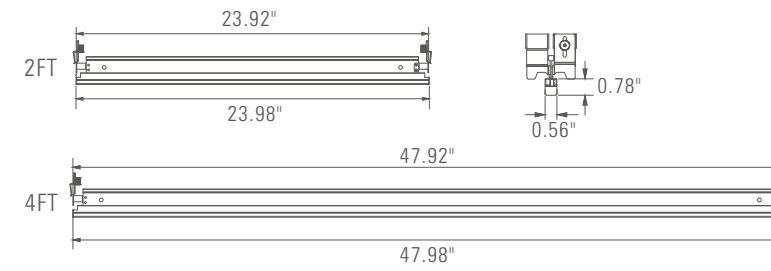

9/16" Interlude

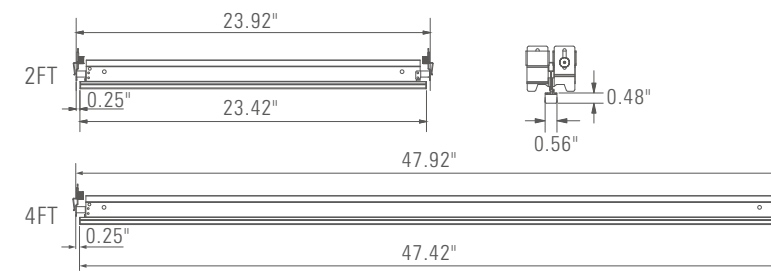

15/16" Flat

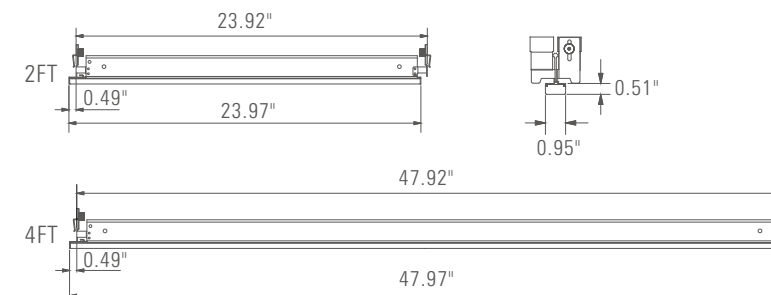



Floating Curved Troffer

Designed to deliver uniform and soft illumination with back-lit technology, it features a compact yet sturdy aluminum construction designed to blend into modern architectural spaces.

Back-lit

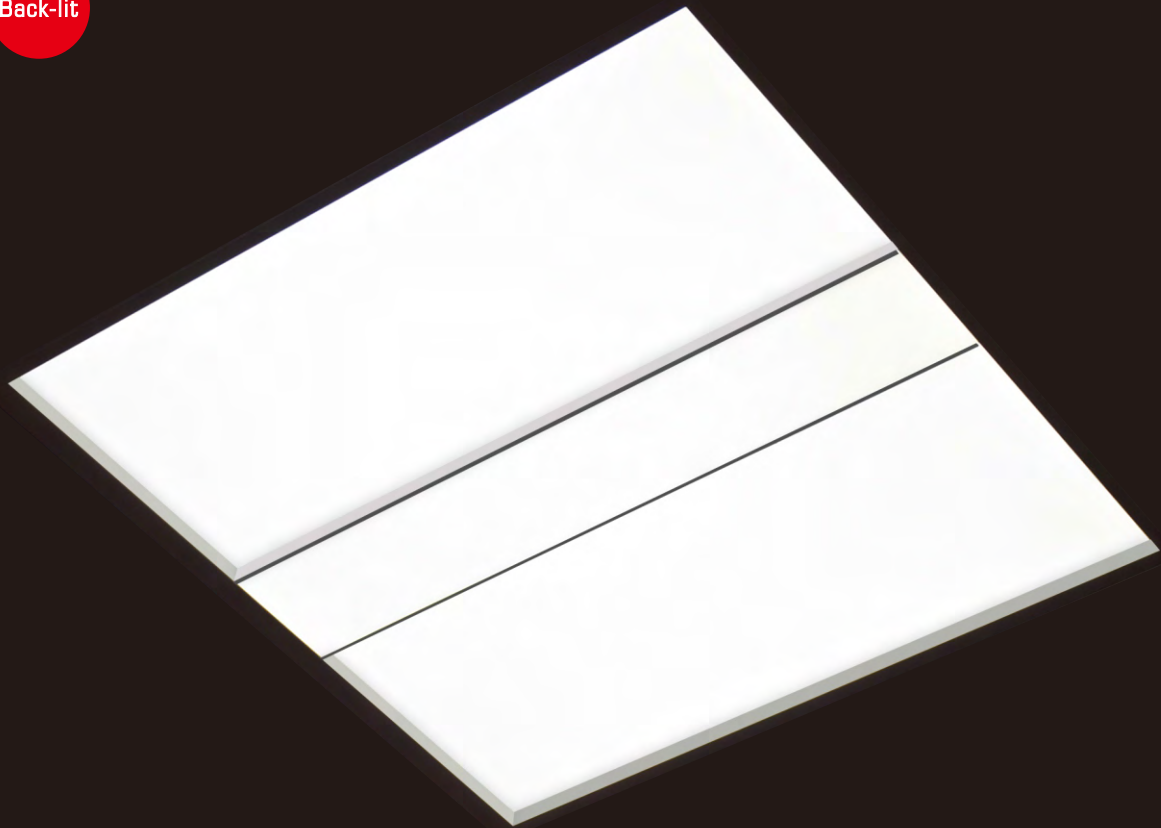

— Architectural curved lens design

— 2'x2', 2'x4' and 1'x4',

— DLC Standard or DLC Premium

— Evenly illuminated, superior visual comfort

— CCT & Wattage Adjustable

Floating Air Troffer

It is an innovative LED luminaire designed to deliver a modern aesthetic, showing a nearly transparent luminaire when off and excellent uniformity and efficiency when on.

Edge-lit

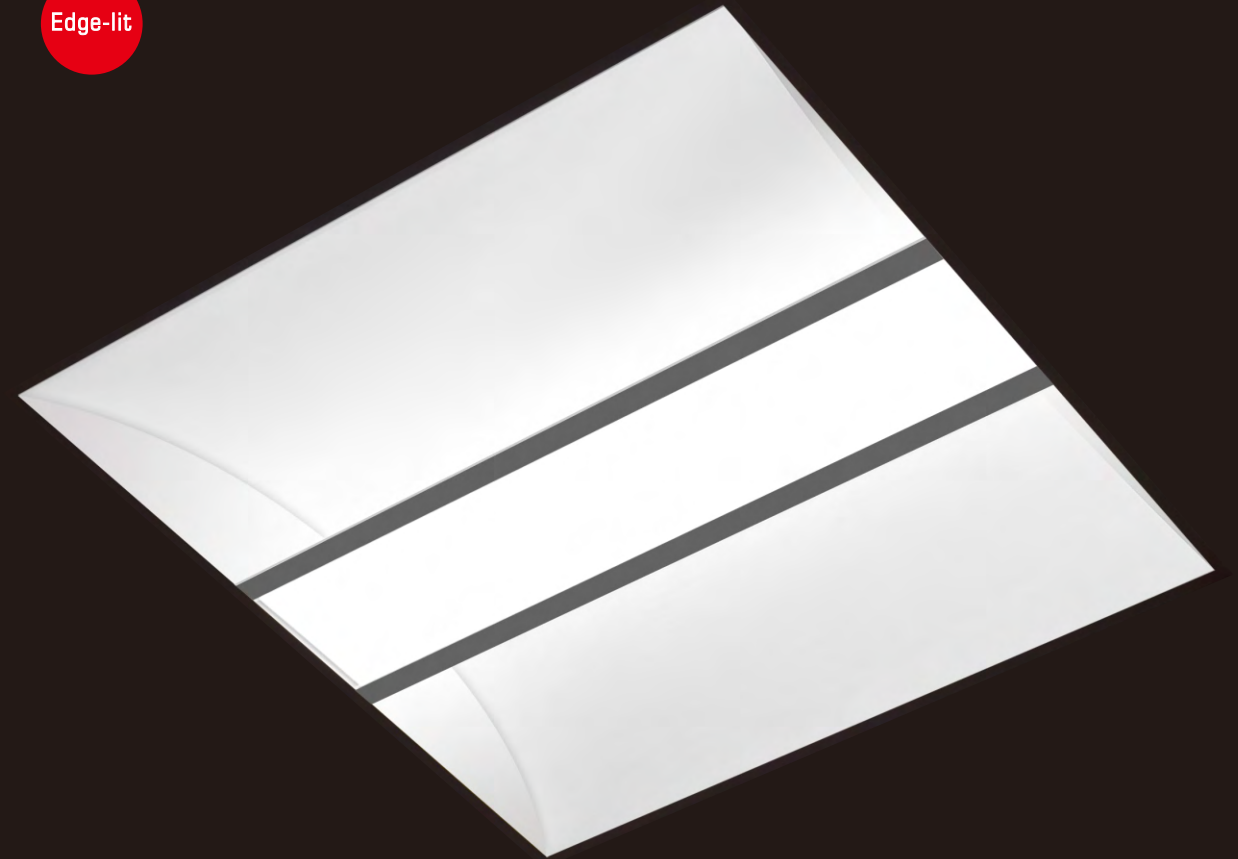

— US Patent US D921,955S

— Superior aesthetic with transparent optics

— 2'x2' and 2'x4', DLC Standard

— CCT & Wattage Adjustable

Floating Air Troffer



It is an innovative LED luminaire designed to deliver a modern aesthetic and complement today's interior spaces, creating a soft and comfortable lighting experience for commercial and institutional spaces including open offices, classrooms, retail and healthcare facilities.

Direct & Indirect Light, Optimal Performance
Unique design with floating light engine spans the light across the bottom of the luminaires precisely controlled optimal direct indirect light distributions between the direct down to the work surface and indirect ambient.

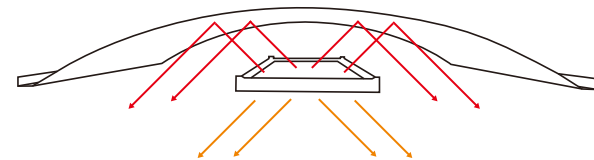

— US Patent US D921,955 S

— 2'x2' and 2'x4', DLC Standard

— CCT adjustable
3000K, 3500K, 4000K

— Wattage selectable

— Emergency or Sensor option



Performance



① Brings Your Space Elegant

Unique design with floating light engine spans the light across the bottom of the luminaires precisely controlled optimal direct indirect light distributions between the direct down to the work surface and indirect ambient.

② Wattage & CCT adjustable

It is stocked with wattage & CCT adjustable, helping wholesaler lower their stock risk while providing designers, contractors and engineers with the ultimate control of their spaces.

③ Save Your Cost

OKT Lighting's floating curved troffer offer the built-in led emergency driver to provide critical illumination when normal power failed for any reason. We also offer built-in motion sensor to meet your different needs.

- **Save Your Shipping Cost**
Same packaging with built-in emergency driver or sensor
- **Save Your Labor Cost**
Built-in indicator. NO J-BOX, NO WIRING!
- **Save Your Installation Cost**
Simple wiring, same as usual

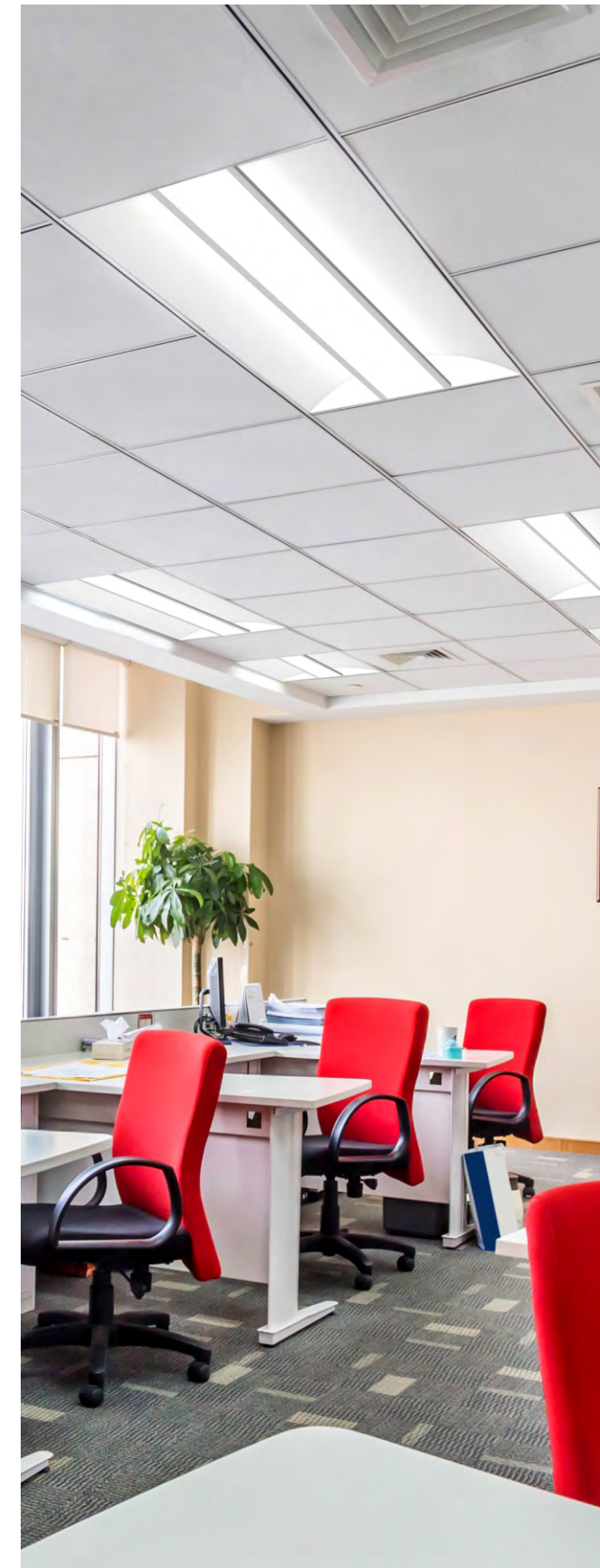





Floating Curved Troffer

Designed to deliver an unprecedented uniformity and functionality, this floating curved troffer features a compact yet sturdy aluminum construction designed to blend into modern architectural spaces. Featuring a low profile form factor, it is ideal for buildings with a low plenum space and is suitable for all standard grid ceilings. The specification grade TR Series is available in 2x2, 2x4, 1x4 sizes and perfect for offices, schools, and healthcare applications, goes beyond what was previously possible with traditional LED luminaires.

—
2'x2', 2'x4', 1'x4'

—
DLC Standard or DLC Premium

—
Uniform and soft illumination

—
Back-lit technology

—
Emergency or Sensor options





Emergency

Performance

— CCT adjustable 3500K, 4000K, 5000K

— Wattage selectable

— Built-in Emergency option

— Built-in smart lighting control option



Save Your Cost Built-in Emergency

OKT Lighting's floating curved troffer offer the built-in led emergency driver to provide critical illumination when normal power fails for any reason. We also offer built-in motion sensor to meet your different needs.

- **Save Your Shipping Cost**
Same packaging with built-in emergency driver or sensor
- **Save Your Labor Cost**
Built-in indicator. NO J-BOX, NO WIRING!
- **Save Your Installation Cost**
Simple wiring, same as usual

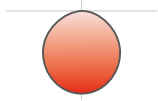
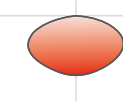

Specification-grade

	Floating Curved Troffer			Floating Air Troffer	
	TR22	TR24	TR14	TT22	TT24
Dimension	2'X2'	2'X4'	1'X4'	2'X2'	2'X4'
Wattage Selectable	25W/30W/35W	30W/40W/50W	25W/30W/35W	20W/30W/40W	30W/40W/50W
Efficacy	110lm/w DLC Standard 125lm/w DLC Premium	110lm/w DLC Standard 125lm/w DLC Premium	110lm/w DLC Standard	110lm/w DLC Standard	110lm/w DLC Standard
CCT Adjustable	3500K / 4000K / 5000K			3000K / 3500K / 4000K	
LED	Back-lit with even illumination			Edge-lit with transparent optics	
Driver	110-277VAC standard, 110-347VAC optional			110-277VAC	
Dimming	1-10V, 10% dimming			1-10V, 10% dimming standard, 1% optional	
Smart Lighting Control Option	YES			N/A	
Beam Angle					
CRI	80+				
Finish	Alpine White				
Emergency Option	Built-in emergency driver				
Certificate	UL Listed, DLC Qualification, Damp Rated				
Flange Kit	YES				
QuickShip	YES				

Dimension

Floating Air Troffer

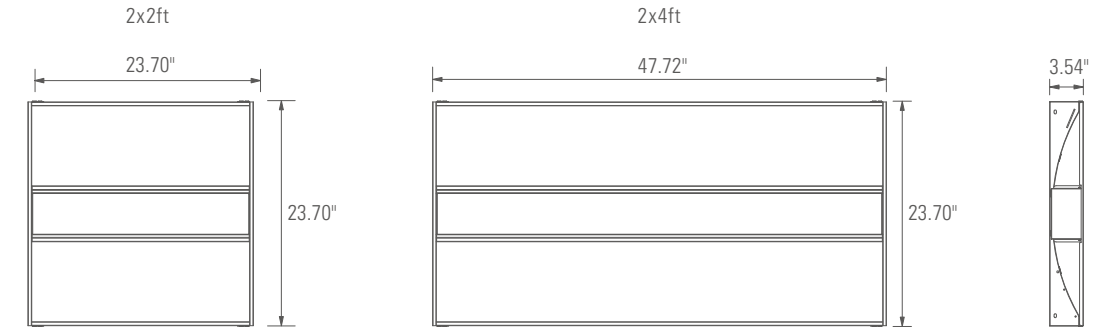

Floating Curved Troffer

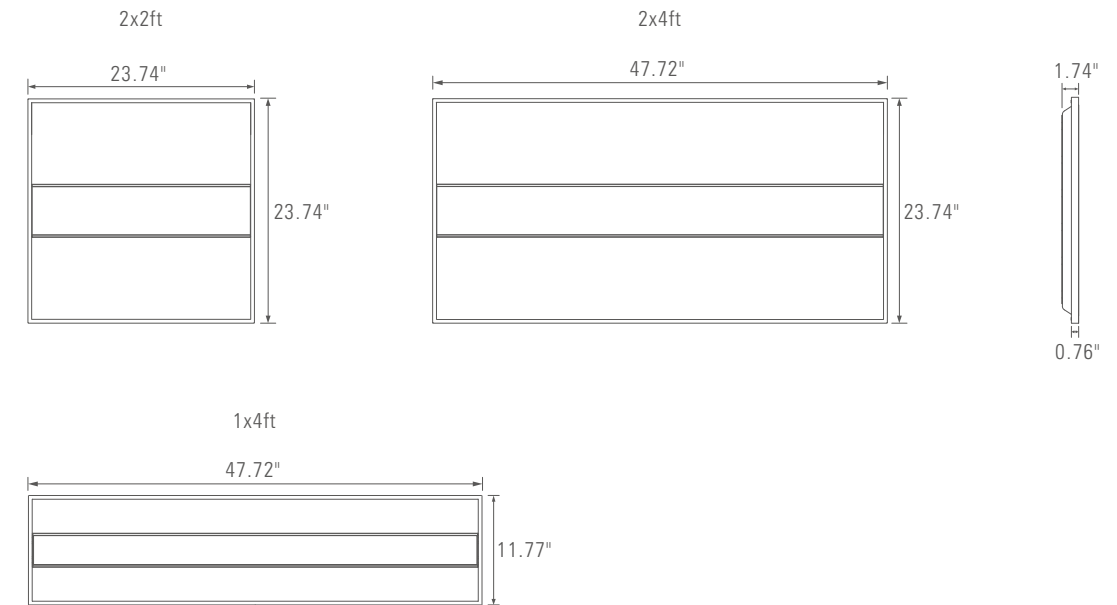

Deep Regressed Downlight



Why OKT?

CES LED downlight series has been handling any lighting retrofit or new construction since 2013. And now, they have been upgraded to Gen 4 in 2020. This downlight system represents the culmination of OKT engineering experience. It is the ideal way to retrofit incandescent, CFL and HID to LED into existing recessed housing or frame-in kit.

10 Years Experience Since 2013

Widely used and Quality Assurance

Wide Compatibility,
18W to 80W, up to 8500lm

Low Glare

Damp Rated. Wet Rated optional





True color
every time

Modular Design



Connect LED engine and trim in a fast way

We've made every engine to work seamlessly with the all trims, making it truly modular. It is designed and engineered for recessed applications, which is suitable for commercial and public places, such as shopping mall, hospital, airport, hotel lobby, etc.

Split Design,
Saving Shipping Costs

One engine allows for seamless
integration of multiple trim size

Twist & Lock feature for easy trim
installation

CCT and wattage adjustable,
fulfill more orders with fewer SKUs

Easy Installation

It is the ideal way to upgrade virtually any existing incandescent, CFL and HID commercial open frame rough-in section to high-performance LED illumination in a matter of minutes. It is provided with spring steel friction clips allowing for installation. Quick disconnection in j-box allows for easy wiring of retrofit conduit whip assembly without reflector interference.



An Ideal Match, Downlight + Frame Kits

New Construction Frame Kits Option

The frame kit was specifically designed for the CES series, it delivers the perfect aperture for a tight, seamless fit. This minimizes the space and materials required for installation. Steel housing frames are suitable for new construction. They are available in 4inch, 6inch, 8inch and 10inch.



Specification-grade

1000~2000LM



Wattage Selectable
14W, 20W, 27W
Efficacy
80LM/W
CCT Adjustable
3000K
3500K
4000K
Trim Options
4"

1500~3500LM



Wattage Selectable
18W, 27W, 40W
Efficacy
85LM/W
CCT Adjustable
3000K
3500K
4000K
Trim Options
6", 8", 10"

4000~8500LM



Wattage Selectable
50W, 65W, 80W
Efficacy
Up to 100LM/W
Optional CCT
3000K
3500K
4000K
Trim Options
6", 8", 10"

LED

CRI: > 80
Lifetime: > 50,000H L70 minimum

Driver

THD < 20%
Power Factor > 0.90
100-277V AC Standard
1-10V, 10% dimming standard, 1% optional
Tested Dimmers: Lutron® Diva-Dvtv, Leviton® IP-710-DL

General

Finish: Chrome
Materials: Extruded Aluminum
Listings: UL, Energy Star, LM79, LM80
Application: Damp rated. Wet rated optional
Warranty: 5 Years Limited
Mounting: Recessed

Function Options

Emergency Option (OKT Model#EM-L0854-LBF and EM-L2554-LBF)

Luminous Intensity Distribution Diagram

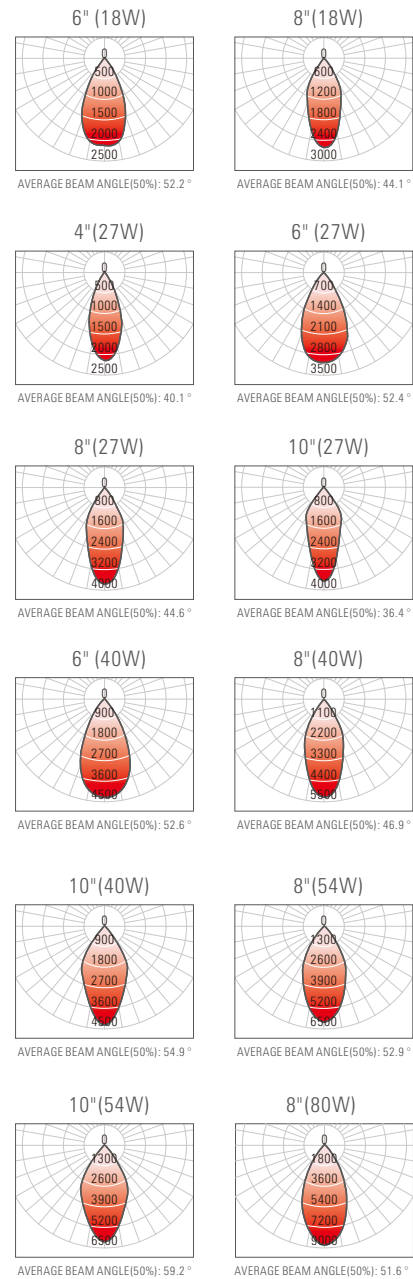

Trim Sizes

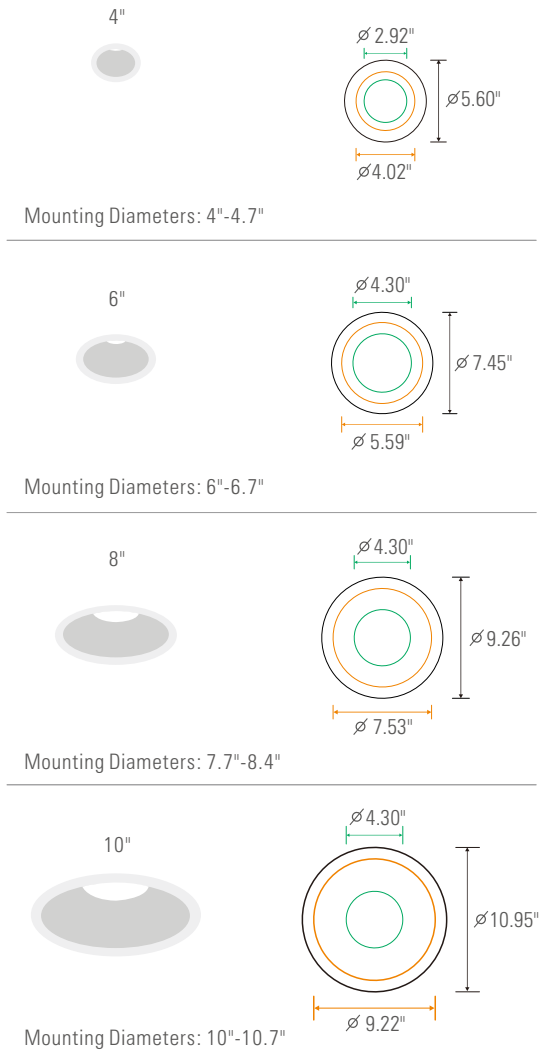

Optional Housing

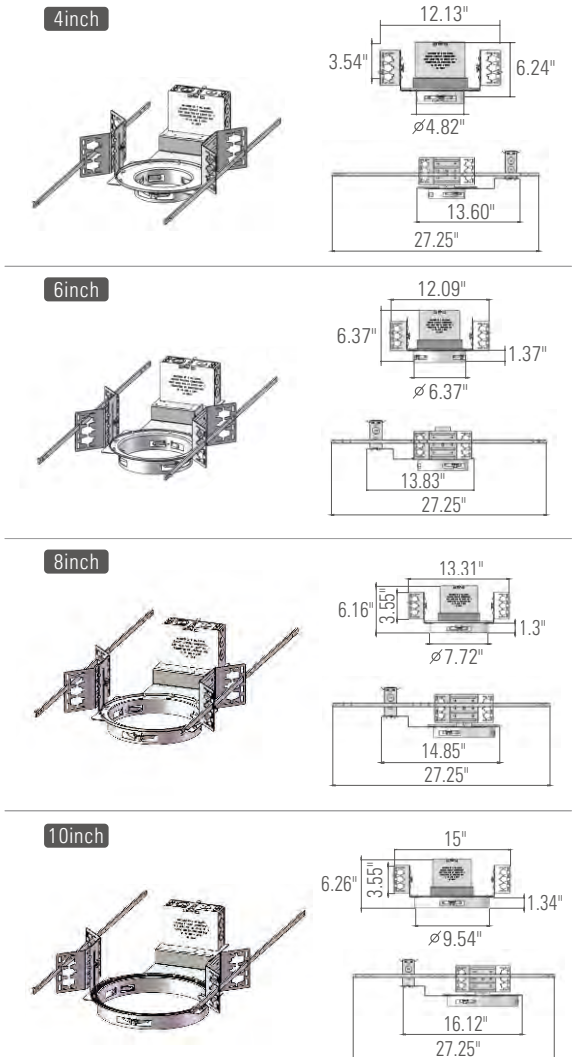

J-Box Downlights



New construction in mind

It is a breakthrough addition to the downlight family. The downlight is built with an integral junction box that eliminates the need for a traditional recessed housing and mounts directly into ceiling in the new construction. It is easy to install in new construction projects. The fixture simply gets wired to a wall switch and placed into the ceiling - no can, bulb or extra labor required!



40W maximum, up to 3200lm

Twist-lock modular design

Integrated J-box for direct wire

Various options of trim sizes and shapes



Modular Design

The split design features an advanced LED light engine mounted directly to the aluminum haze trim with integral white trim ring. It is the perfect foundation for a fully interchangeable system of modules and trims that give you endless choice over how your lighting works and looks.

—
Innovative separated design, made it simpler, saving shipping costs

—
One engine allows for seamless integration of multiple trim options

—
CCT and wattage adjustable, fulfill more orders with fewer SKUs

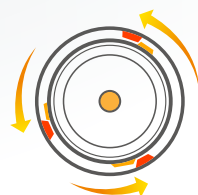

The Twist & Lock feature allows for easy, tool-free installations and seamless integration of multiple trims.

Solution for every project

We offer various options for trim sizes and shapes. A stunning range of results, one product family can illuminate a whole project with your choice of light and aesthetics options. It can deliver exactly what your project demands

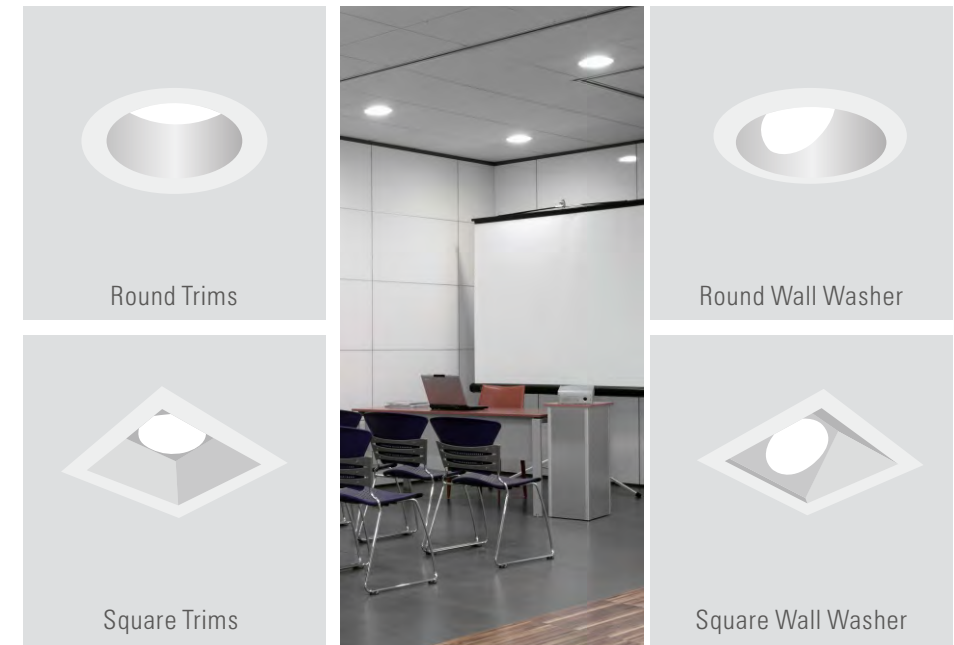

Save Your Cost

No Can Required Saving Job Site Cost !

The downlight is built with an integral junction box that eliminates the need for a traditional recessed housing and mounts directly into ceiling in the new construction.

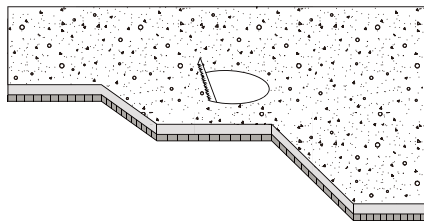

Easy Wiring save your installation cost

The fixture simply gets wired to a wall switch and placed into the ceiling.

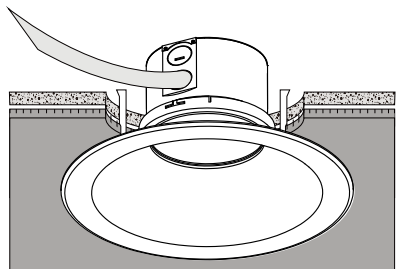

Innovative New Construction Frame Kits Option

An Ideal Match, CP Downlight + Frame Kits

OKT engineers understand how challenging it can be to install full range CP series downlight in one frame kit and perfectly aligned for new construction. That's why they've incorporated a suite of features that work together seamlessly to give you a flawless fit more and with less hassle. This frame kit can suitable for round trims from 3" to 8".



Specification-grade

800~1500LM



2400~3200LM



Wattage Adjustable

10 Watts
15 Watts
20 Watts

CCT Adjustable

3000K 3000K
3500K or 4000K
4000K 5000K

Efficacy

80lm/w

Input Voltage

120-347V

Type

IC

Wattage Adjustable

27 Watts
34 Watts
40 Watts

CCT Adjustable

3000K
3500K
4000K

Efficacy

85lm/w

Input Voltage

120-347V

Type

NON-IC

General

CRI: > 80

THD < 20%

Power Factor > 0.90

1-10V Dimmable Driver

Tested Dimmers: Lutron ® Diva-Dvtv, Leviton ® IP-710-DL

Finish: Silver

Materials: Extruded Aluminum

Listings: UL, Energy Star, LM79, Lm80, Damp Rated

Warranty: 5 Years Limited

Mounting: Recessed

Function Options

Emergency Option (OKT Model#EM-H08170-LBF)

Luminous Intensity Distribution Diagram

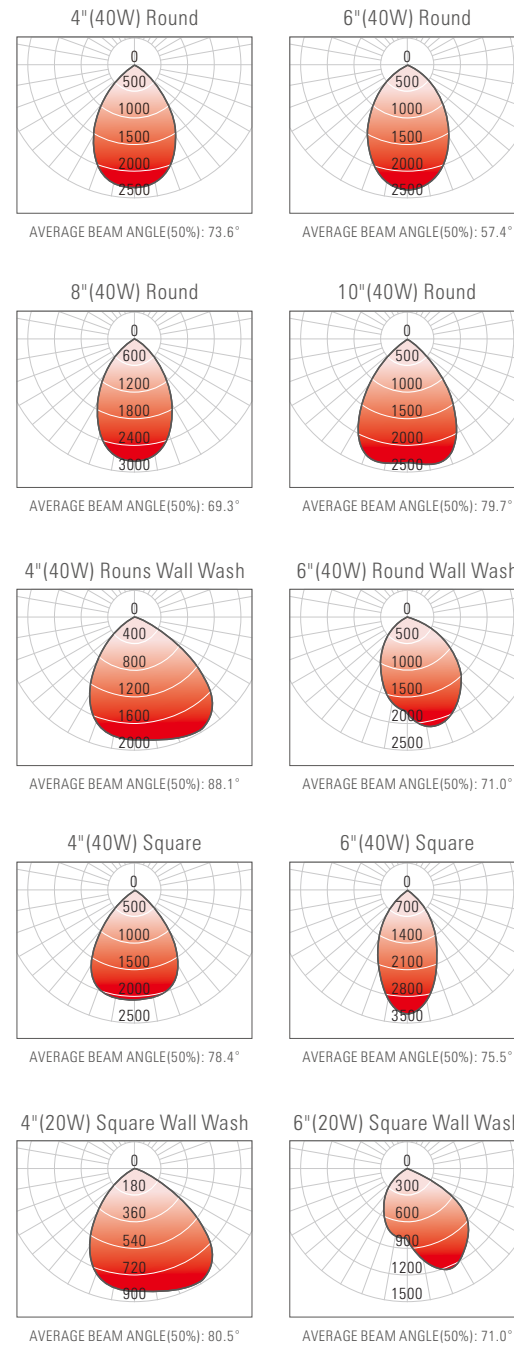

Compatible Trims Options



Optional New Construction Frame Kits

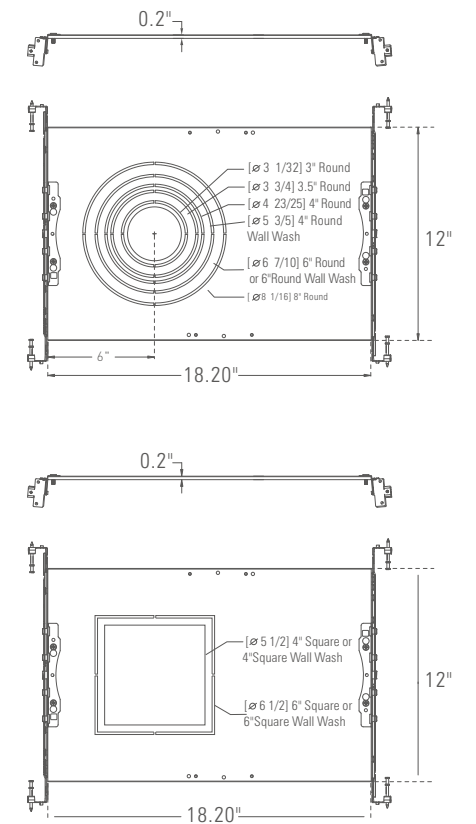

COPA 3" Downlight



A Brilliant Innovation

Thanks to a unique low profile and small aperture design, it provides you with high quality, cost effective LED lighting in practically any space. Its broad compatibility simplifies the specification process making installing or replacing the light and trim fast and tool-free. 90+ CRI option, produces outstanding illumination at a tight chromaticity specification and color binning process to ensure CRI and CCT consistency.

3" Small Size

Powered by bridgelux COB LED chip

Modular design

Easy installation

TRIAC/120V or 1-10V/100-277V

True color ,90+ CRI

MR16 standard size

Available in 24°, 36° and 60° beam angle



Perfect match for whatever you need

We offer highly customizable options for trim color, shape and mounting accessory. That means you can choose whether the fixture blends in seamlessly or provides a striking contrast.



Optional Trims



Round Trim



Adjustable Round Trim



Square Trim



Adjustable Square Trim

Optional Accessories



Recessed housing for new construction



Driver box for retrofit



Specification-grade

900LM



IC

Input Power

10 Watts

Luminous Flux

>900 lm

Efficacy

90 lm/w

Beam Angle

24°, 36°, 60°

Input Voltage

AC 120V (TRIAC Dimming)
AC 100-277V (1-10V dimming)

LED

CCT: 3000K, 4000K

Chip: Bridgelux COB LED Chip

CRI: 90+

Lifetime: >50,000H L70 minimum

Driver

THD < 20%

Power Factor > 0.90

External UL Driver

General

Fit in most mr16 LED downlight converters

Materials: Extruded Aluminum

Listings: UL, Damp Rated

Warranty: 5 Years Limited

Mounting: Recessed

Function Options

Emergency Option (OKT Model#EM-L0854-LBF)

1700LM



NON IC

Input Power

18 Watts

Luminous Flux

>1700 lm

Efficacy

95 lm/w

Beam Angle

24°, 36°, 60°

Input Voltage

AC 120V (TRIAC Dimming)
AC 100-277V (1-10V dimming)

Luminous Intensity Distribution Diagram

24°-10W-3000K

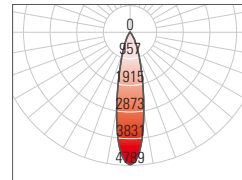

AVERAGE BEAM ANGLE(50%): 21.4°

24°-18W-3000K

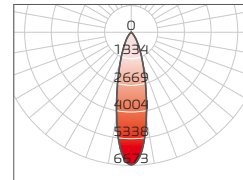

AVERAGE BEAM ANGLE(50%): 25.6°

36°-10W-3000K

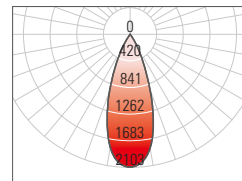

AVERAGE BEAM ANGLE(50%): 36.1°

36°-18W-3000K

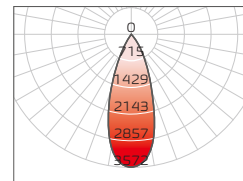

AVERAGE BEAM ANGLE(50%): 37.2°

60°-10W-3000K

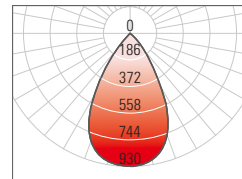

AVERAGE BEAM ANGLE(50%): 60.6°

60°-18W-3000K

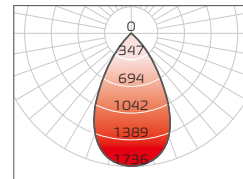

AVERAGE BEAM ANGLE(50%): 59.3°

Trim Options

Round Trim

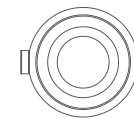

3.35"

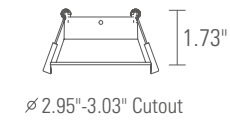

∅ 2.95"-3.03" Cutout

Square Trim

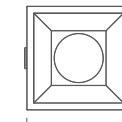

3.35"

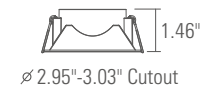

∅ 2.95"-3.03" Cutout

Adjustable Round Trim

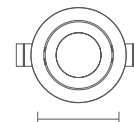

3.35"

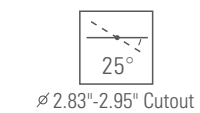

∅ 2.83"-2.95" Cutout

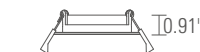

0.91"

Adjustable Square Trim

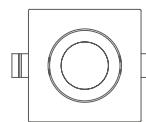

3.74"

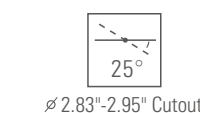

∅ 2.83"-2.95" Cutout

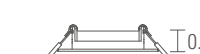

0.98"

Optional Accessory



Driver box for retrofit



Can housing for new construction

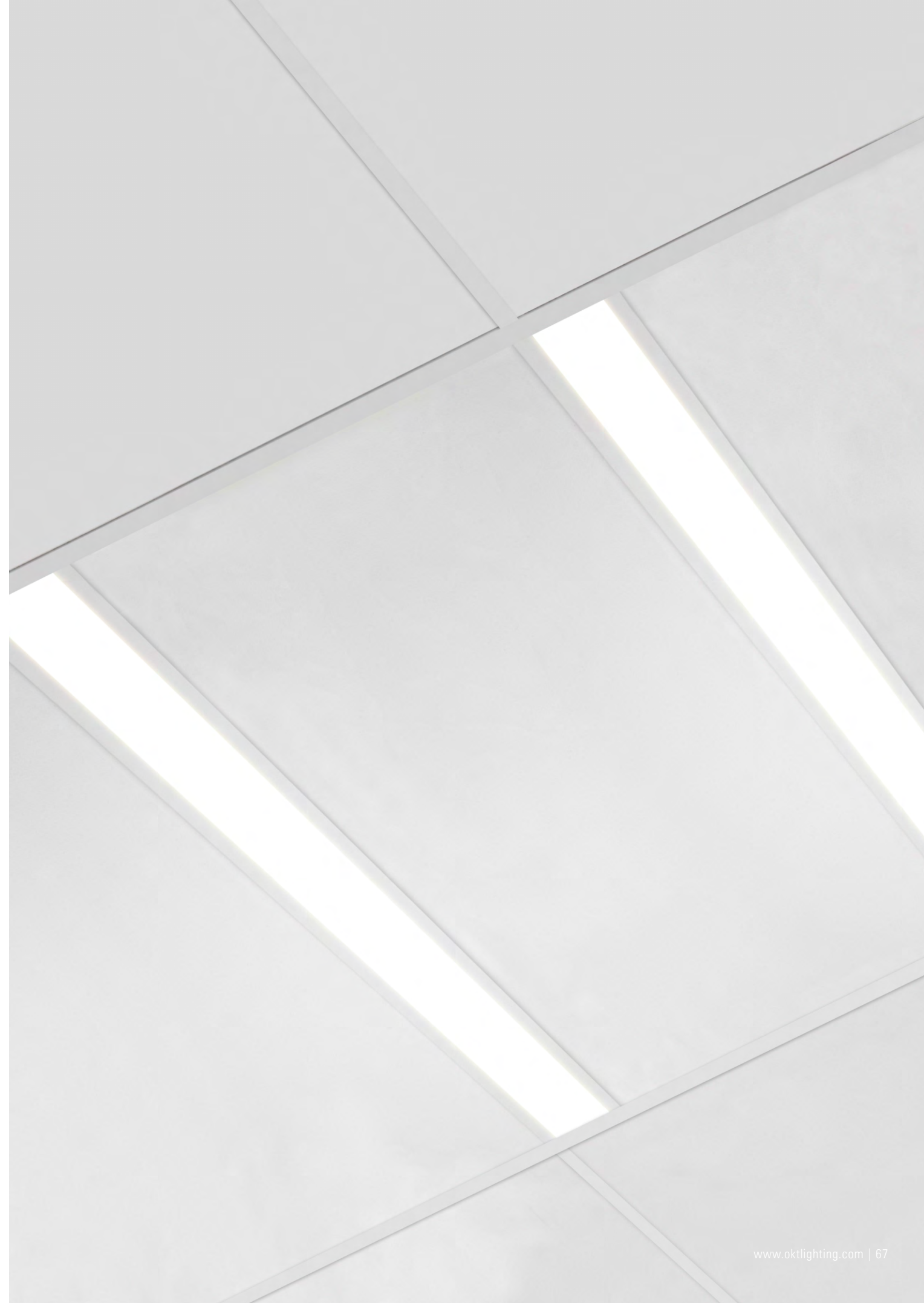

Slim Recessed Linear

LR Series

Rethink recessed linear fixture family with external driver is designed to please wholesalers, architects, contractors and designers. It is a perfect lighting solution that compliments the ceiling and entire space while providing comfortable general illumination which will be your go-to-choice for offices, schools, hospital, corridor light industrial spaces or anywhere stylish lines of light are desired. Sleek and simple, thin lines of light integrate with architecture for maximum impact and design flexibility.



— Features popular 4", 6" width and length up to 8'

— Slim and linear design

— Up to 950lm/ft

— Fit most ceiling types

— Smooth, even illumination

Performance

① CCT and wattage adjustable

Most of our customers have been struggling with inventory control, thanks to the CCT and wattage adjustable technology, you can now fulfill more orders with fewer SKUs! Configure 18 options with only 6 SKUs

- Wattage selectable (50%/75%/100%)
- CCT adjustable from 3000K, 3500K and 4000K



② Easy mounting

Easy mounting in T-bar ceilings with dimensions of 4" x 2', 4" x 4', 4" x 8', 6" x 2', 6" x 4', 6" x 8'.





Specification-grade

	LR24	LR44	LR84	LR26	LR46	LR86
Width	4"	4"	4"	6"	6"	6"
Length	2'	4'	8'	2'	4'	8'
Wattage Selectable	10W/15W/20W	20W/30W/40W	40W/60W/80W	10W/15W/20W	20W/30W/40W	40W/60W/80W
Efficacy	85lm/w	90lm/w	90lm/w	100lm/w	100lm/w	100lm/w
Lumens	Up to 1700lm	Up to 3600lm	Up to 7200lm	Up to 2000lm	Up to 4000lm	Up to 8000lm
CCT Adjustable	3000K/3500/4000K adjustable					
Driver	External, 110-277VAC					
Dimming	1-10V, 10% dimming standard, 1% optional					
CRI	80+					
Finish	Alpine White					
Optional Function	Emergency Option (OKT Model #EM-L0854-LBF or EM-L2554-LBF)					
Mounting	Recessed					
Certificate	UL Listed					
Flange Kit	YES					
QuickShip	N/A	YES		YES		

Dimension



RECESSED
ZETA 2.3"

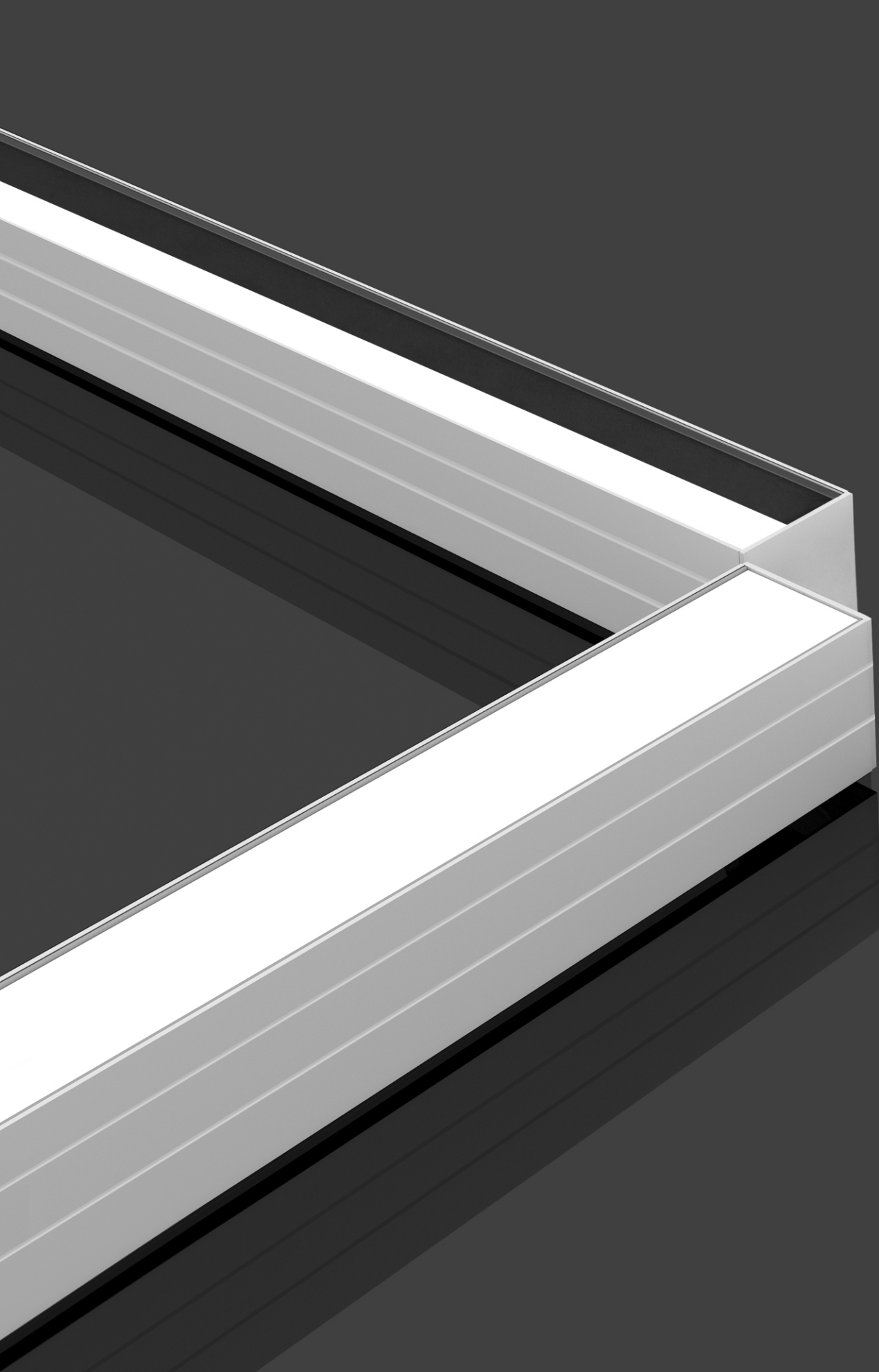

ZETA 2.3\"/> RECESSED

Minimal width Maximum performance

It is an integrated lighting solution that compliments the ceiling and entire space while providing comfortable general illumination. Sleek and simple, thin lines of light integrate with architecture for maximum impact and design flexibility. It is ideal for a variety of indoor applications including offices, institutions and commercial spaces. Installation and maintenance are made easy and access to all components from below.

Trimless design

T-grid/drywall ceiling compatible

Flat, recess lens are available

Seamless continuous runs or custom pattern with 2',3',4' and 8' lengths options

Illuminated corner

CCT & wattage adjustable
Up to 1000lm/ft



Recessed in Drywall

Trimless

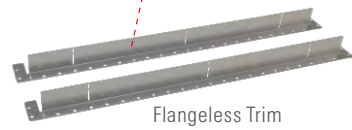
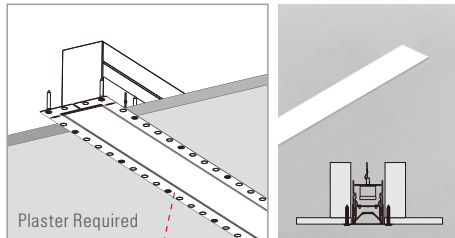

Trim

Recessed with pendant stem

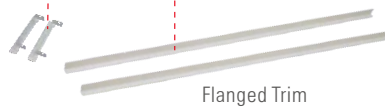
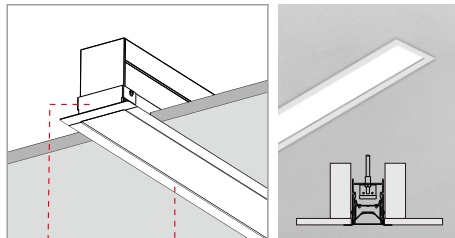

Recessed with brackets

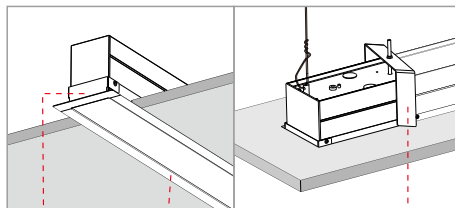

Recessed in Grid Ceiling

T-Grid Hook

ZETA 2.3" luminaires offer grid mount which can fit easily in a variety of T-Grid ceiling types, allowing to be fully and seamlessly integrated into 9/16" flat, 9/16" slot or 15/16" flat T-grid ceiling types. It supports to be installed in individual or seamless continuous runs.

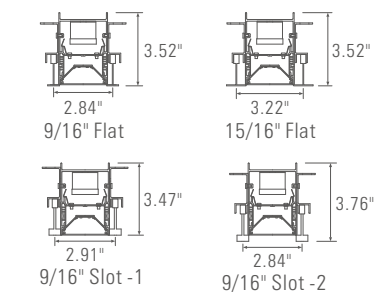

Trimless

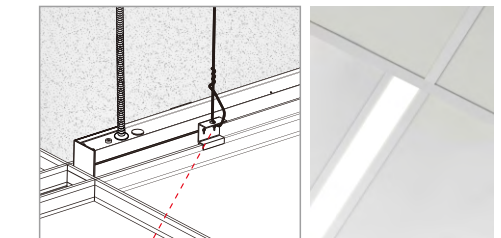

Trim

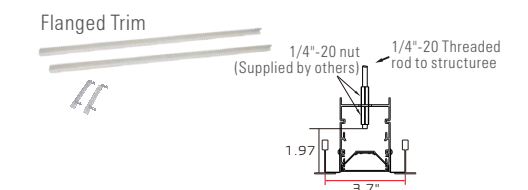
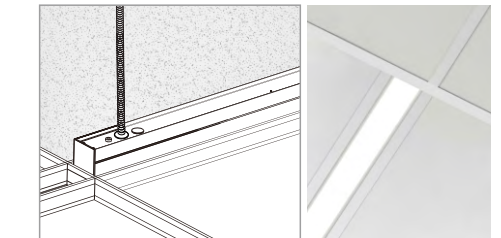



A Winning Combination

ZETA 2.3 recessed, is the perfect blend of lighting performance and timeless aesthetic. It is stocked with wattage & CCT adjustable, you can fulfill more orders with fewer SKUs! It is also compatible for more essential functions to meet your different needs, including the occupancy sensing modular or emergency modular to provide critical illumination when normal power failed for any reason, allowing projects to remain well under lighting power allowances and comply with building energy codes.

CCT Adjustable
3000K/3500K/4000K

Wattage Selectable
100%/75%/50%

Occupancy Sensor Module Option

Emergency Module Option

OCCUPANCY SENSOR

EMERGENCY

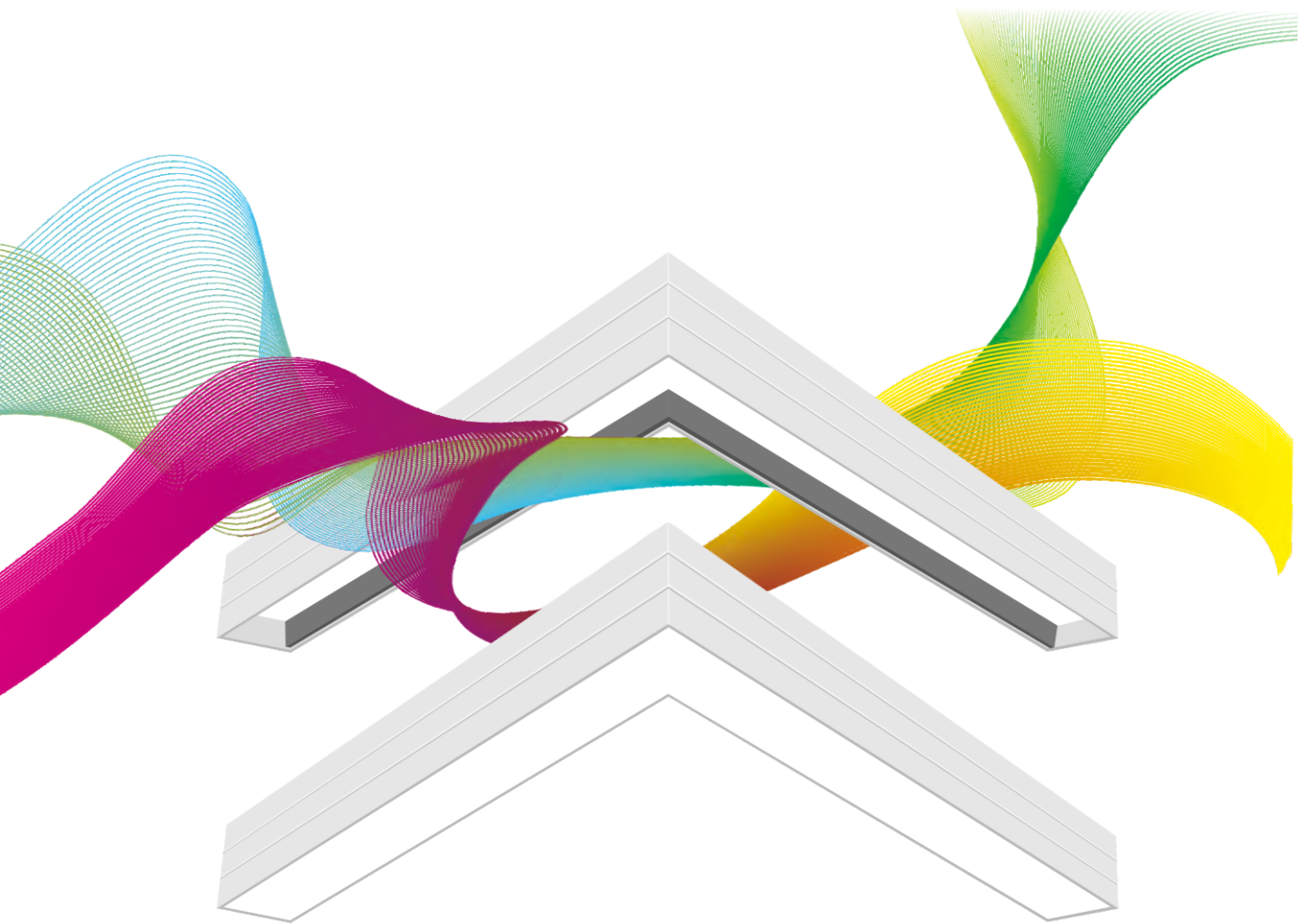

An Evolution In Design Freedom Creative • Powerful • Integrated

ZETA 2.3" offers new opportunities to capture the beauty and benefits of architectural recessed linear lighting that can add rhythm, beauty and creativity to the ceiling plane, while providing opportunities for customized lighting design. With their streamlined aesthetics and uniform soft illumination, you can enjoy freedom from traditional ceiling footprints and allows you to enhance modern interiors, including offices, public spaces, as well as educational and healthcare facilities.

Simple Installation

Fits easily in a variety of T-grid, drywall trimless applications.

Continuous Runs

Seamless with Line joiner with no socket shadows or hot-spots.

Custom Pattern

Optional L illuminated joiner enables superior lighting design flexibility.



Recessed + Suspended + Surface Mount

Specification-grade

Flat Lens

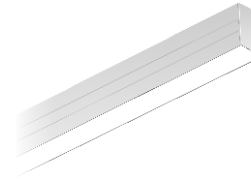

Regressed Lens

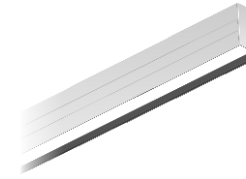

Wattage Selectable

2' : 20w, 15w, 10w
 3' : 30w, 23w, 15w
 4' : 40w, 30w, 20w
 8' : 80w, 60w, 40w

Efficacy

1000lm/ft

CCT Adjustable

3000K
 3500K
 4000K

Input Voltage

110-277V AC Standard
 110-347V AC Opiton

Mounting

Recessed
 Pendant/Surface Options

Wattage Selectable

2' : 20w, 15w, 10w
 3' : 30w, 23w, 15w
 4' : 40w, 30w, 20w
 8' : 80w, 60w, 40w

Efficacy

800lm/ft

CCT Adjustable

3000K
 3500K
 4000K

Input Voltage

110-277V AC Standard
 110-347V AC Opiton

Mounting

Recessed
 Pendant/Surface Options

LED

CRI: 80+ or 90+ option

Lifetime: > 50,000H L70 minimum

Driver

THD < 20%

Power Factor > 0.90

1-10V , 10% dimming standard, 1% optional

Tested Dimmers: Lutron® Diva-Dvtv, Leviton® IP-710-DL

General

Finish : Alpine White or Black

Materials: Extruded Aluminum

Listings: UL

Warranty: 5 Years Limited

Mounting: Recessed (Suspended and Surface Mounted options)

Function Options

Emergency Option (OKT Model#EM-H25170-LBF)

Sensor Option

Dimensions

2FT

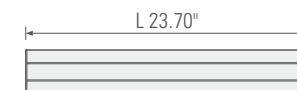

3FT

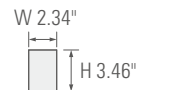
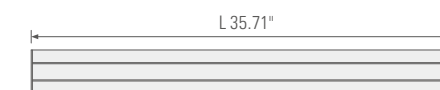

4FT

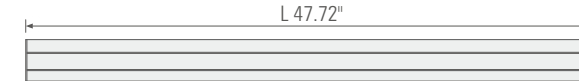

8FT

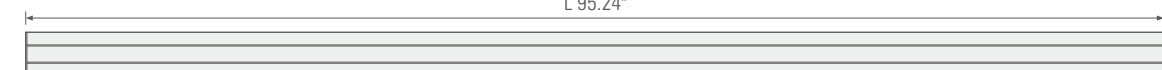

Joiner Options

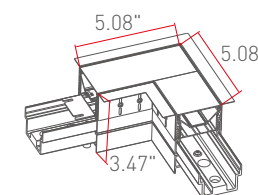

"L" pattern

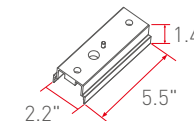

"-" pattern

Suspended Lighting Solutions





ZETA LINEAR

Clean lines • Sleek styling

OKT Zeta series 2.3" linear pendant lighting is a unique linear series that brings any space to the center stage. These timeless, streamlined forms blend well with contemporary decors and modern workplaces. Available in 2ft, 3ft, 4ft and 8ft, it simply provides wide, powerful lighting to any atmosphere with continuous runs or custom pattern. It can provide smooth uplight and downlight, allowing for wider spacing between fixtures and better ceiling light uniformity.



— Wattage & CCT adjustable from 3000K, 3500K, 4000K

— 7 embedded lighting distributions options

— Diffuser, micro reflector, louver and regressed lens options

— Continuous runs, up to 40'

— Custom pattern with optional Line, L, X, T, Y, V, Z joiners



A Wide Range Of Lighting Distributions

When suspended or wall mount, the Zeta Series can provide smooth direct or indirect lighting distribution, allowing for wider spacing between fixtures and better ceiling light uniformity. Up to 7 embedded lighting distributions adjusting by dip switch. With a maximum output of 1000 lm/ft and a choice of various optics, Zeta is capable of delivering the light levels needed for the most demanding applications.

"7-in-1" lighting distribution options:

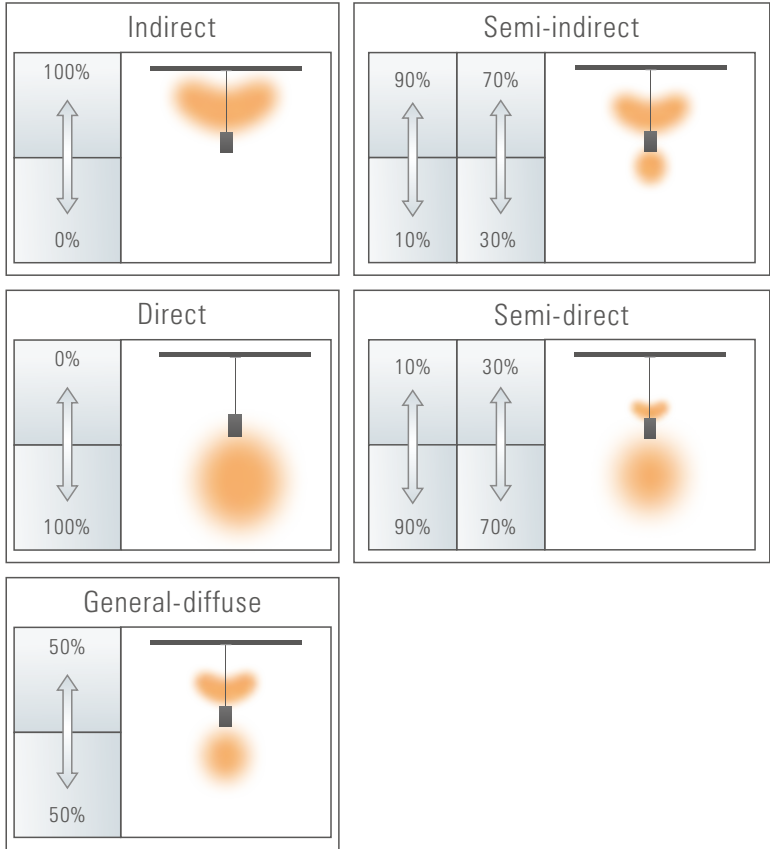



Puts flexibility at your fingertips

① CCT and wattage adjustable

Most of our customers have been struggling with inventory control, thanks to the CCT and wattage adjustable technology, you can now fulfill more orders with fewer SKUs! Configure 18 options with only 6 SKUs

- Wattage selectable (50%/75%/100%)
- CCT adjustable from 3000K, 3500K and 4000K

② Seven lighting distributions selectable

By using dip switch located on the back, you can choose from SEVEN lighting distributions including 100% up, 90% up/10% down, 70% up/30% down, 50% up/50% down, 30% up/70% down, 10% up/90% down, 100% down, creating your optimal lighting experience.

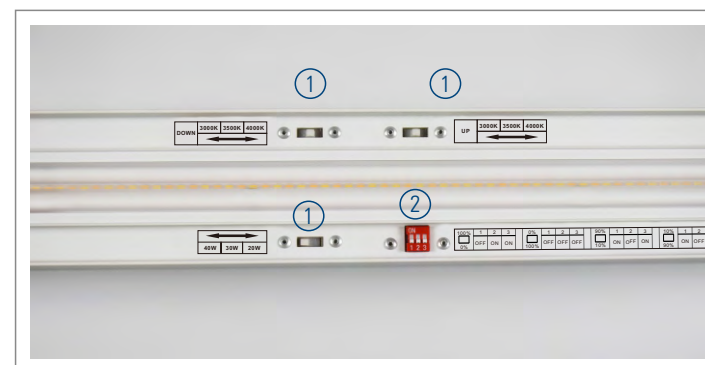

Flexible Architectural Lighting Systems



Linear Lighting



Geometric Lighting



The Art of Stenciling

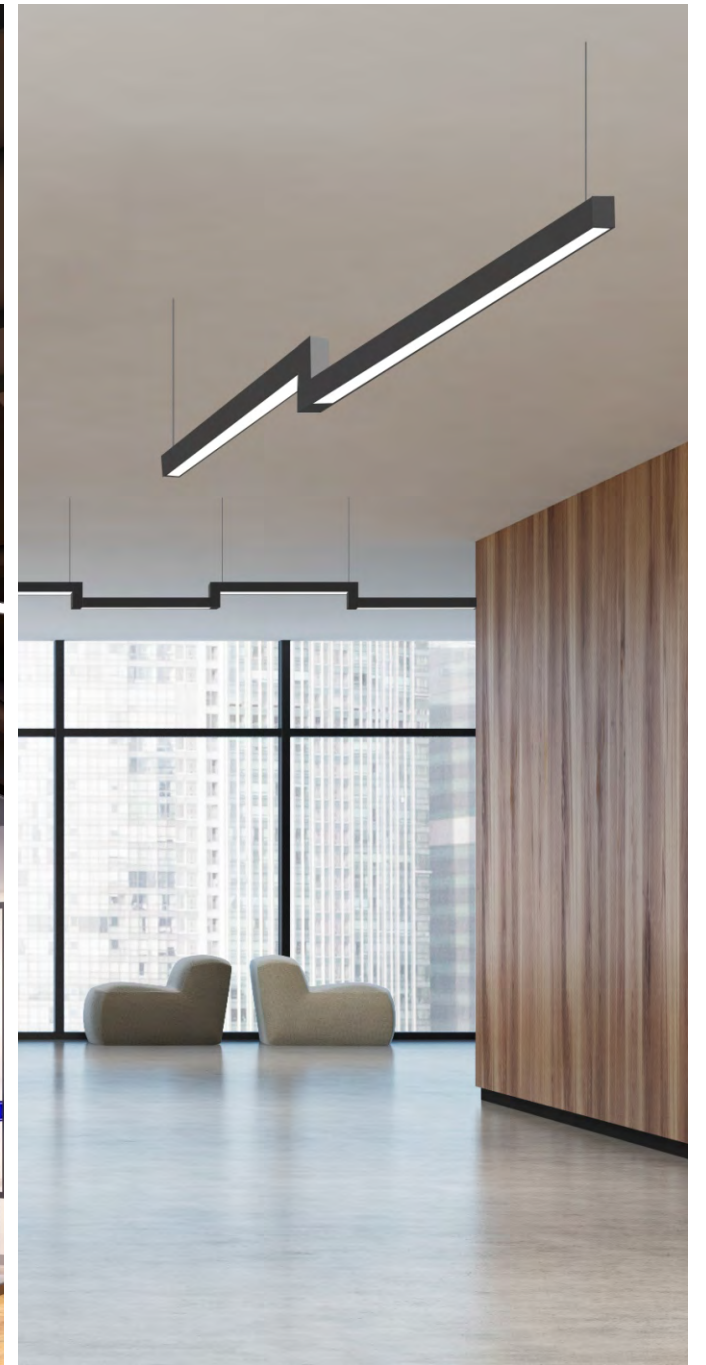

Stereo Design

The Art of Design Flexibility

Seamless Continuous Runs

Create clean, seamless runs that are quicker to install with this quality press-in diffuser lens that will not crinkle or bow. It is available in lengths up to 42'.

42' Continuous Roll-out Lens



Simple Configure Unique Shape

Unleash lighting design flexibility with different patterns, it adds fun factor into each space. A wide choice of joiners increases application flexibility. It results in quick and easy design and installation, shorter project time lines.

Joiner Options

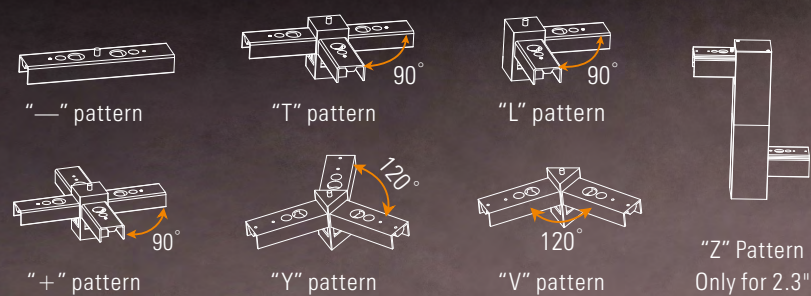



Flexibility for straight or angled connections, and the ability to connect another line on a different plane.



Flexible Lighting Solutions

Versatile Mountings

It can be pendant, surface, wall mount or recessed. It is strategically placed throughout the space to create pleasing illumination, providing the flexibility to adapt to the changing needs of the space or environment.

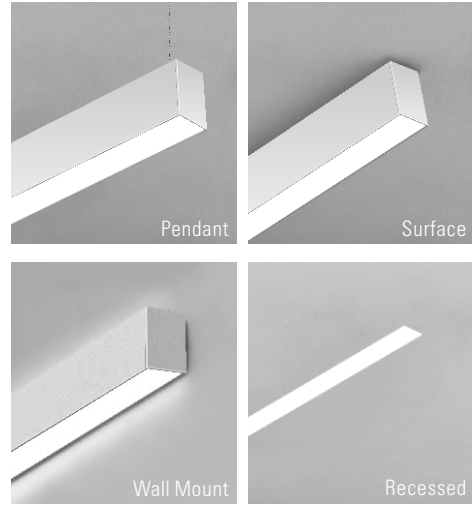

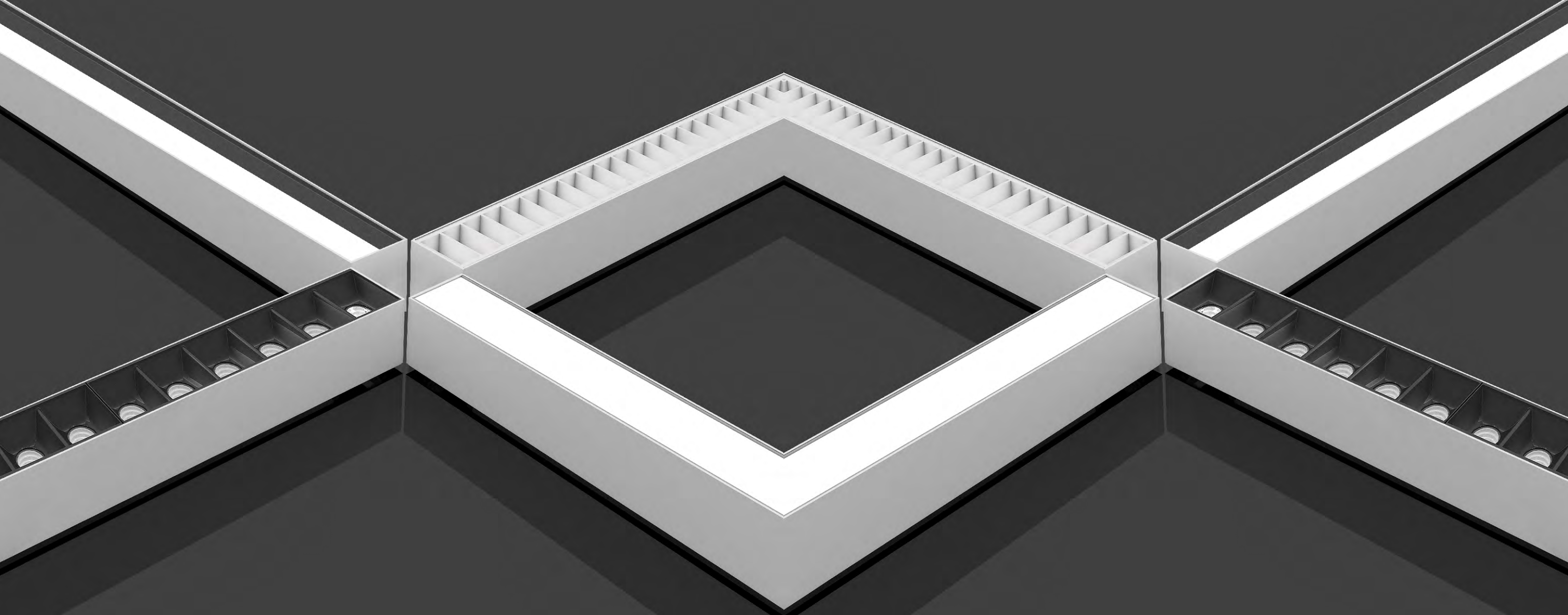

Lens Challenges

Each of these professional lenses challenges the highest glare rating. We are elevating our entire architectural product line to a higher standard.

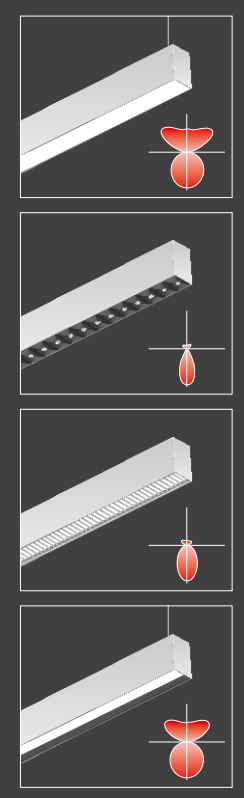

Diffuser 100°
It allows the light to custom the diffuser lengths, seamless runs up to 42'. Available for all sizes.



Micro Reflector 48°
Exclusive low glare modular optics, UGR < 15. Available for 1.3" and 2.3" widths.

Louver 60°
Straight blade louver, allows the light to diffuse for a direct and indirect lighting combination. Available for 1.3" and 2.3" widths.

Regressed Lens
A snap-in lens for easy custom colors and visual comfort. Available for 2.3" widths.

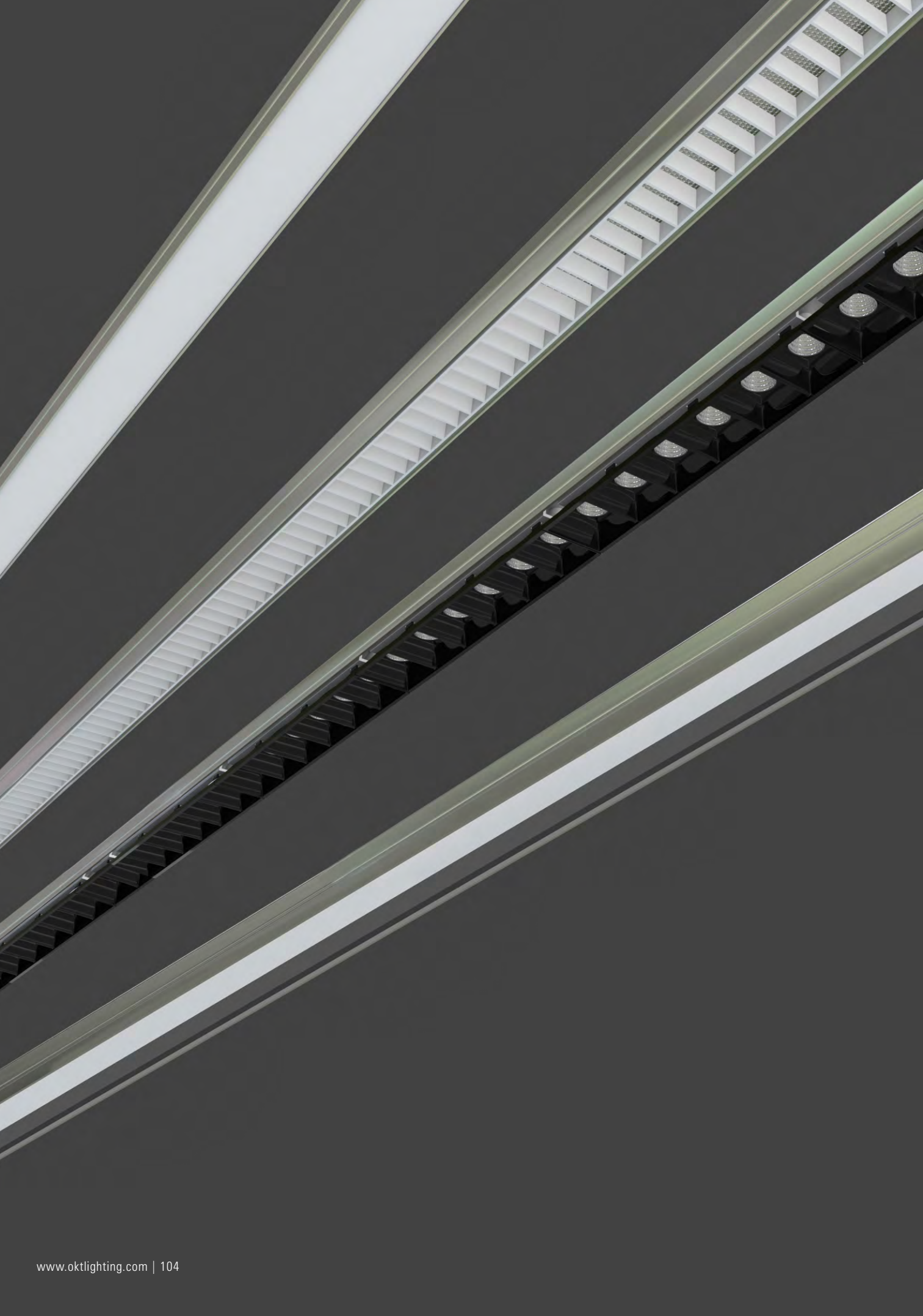

Functional Style

Built on the core of its modern, practical design philosophy, Zeta series allow easy access to critical components to simplify installation or in the event that repair or replace different CCT becomes necessary.

- LEVEL 1**
Up LED Module
High efficiency, up to 1150 lm/ft
- LEVEL 2**
Internal Driver
Replaceable driver, easy to maintain. 1-10V dim, 10% standard. Dim to 1% is optional
- LEVEL 3**
Fixture Housing
Extruded aluminum housing with Powder coat white or black finish
- LEVEL 4**
Down LED Module
A selection of professional lens including diffuser, louver, micro reflector, regressed lens and convex.
- LEVEL 5**
Diffuser /Continuous Rolling Diffuser
42' Continuous Rolling Diffuser is provided to create clean, seamless runs that are quicker to install.

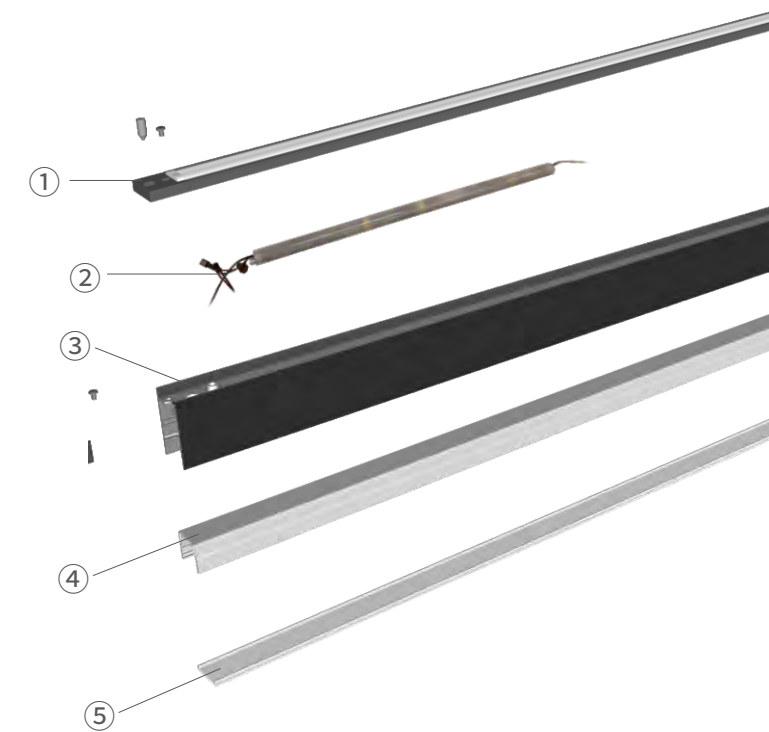

ZETA FAMILY

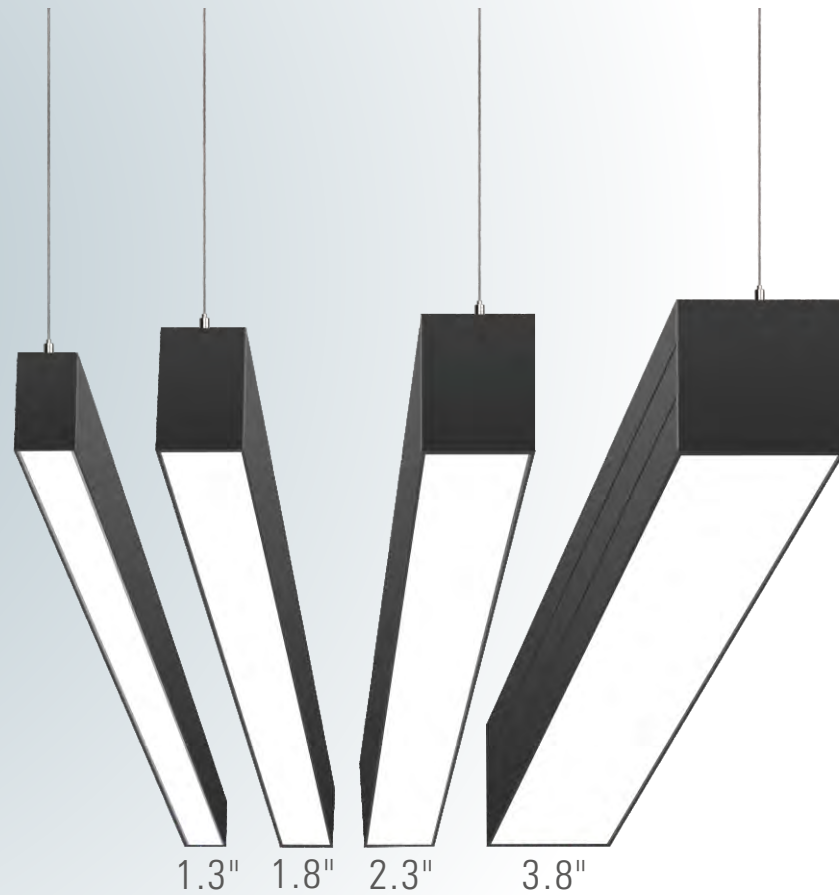

Versatile And Streamlined

Combining superior esthetics, quality performance and unparalleled versatility, Zeta offers new opportunities to capture the beauty and benefits of true lighting. This ZETA solution does it all, in a system with a small scale extruded profile that not only provides straight lines but also well-controlled ambient lighting. It's an excellent choice for commercial and retail ambient applications.

Up to
Four form sizes

Up to
Five optics

Up to
Nine illumination

Endless
Design possibilities

Performance Summary

PRODUCTS	1.3" Zeta Slim	1.8" Zeta	2.3" Zeta	3.8" Zeta
DIMENSIONS				
LENGTHS	2', 4', 8'	2', 4', 8'	2', 3', 4', 8'	2', 3', 4', 8'
OPTICS	Diffuser Louver Convex	Diffuser	Diffuser Louver Micro Reflector Deep Regressed	Diffuser Deep Regressed
MOUNTING OPTIONS	 Pendant Surface	 Pendant Surface	 Pendant Surface Wall Mount Recessed	 Pendant Surface Recessed
SURROUND LITE	 100% Dn 25% Up, 75% Dn	 100% Dn 25% Up, 75% Dn	 100% UP 90% Up, 10% Dn 70% Up, 30% Dn 50% Up, 50% Dn 30% Up, 70% Dn 10% Up, 90% Dn 100% Dn	 100% UP 90% Up, 10% Dn 70% Up, 30% Dn 50% Up, 50% Dn 30% Up, 70% Dn 10% Up, 90% Dn 100% Dn
JOINERS	"—" Pattern, "T" Pattern, "L" Pattern, "+" Pattern, "Y" Pattern, "V" Pattern	"—" Pattern, "T" Pattern, "L" Pattern, "+" Pattern, "Y" Pattern, "V" Pattern	"—" Pattern, "T" Pattern, "L" Pattern, "+" Pattern, "Y" Pattern, "V" Pattern, "Z" Pattern	"—" Pattern, "T" Pattern, "L" Pattern, "+" Pattern, "Y" Pattern, "V" Pattern

Specification-grade

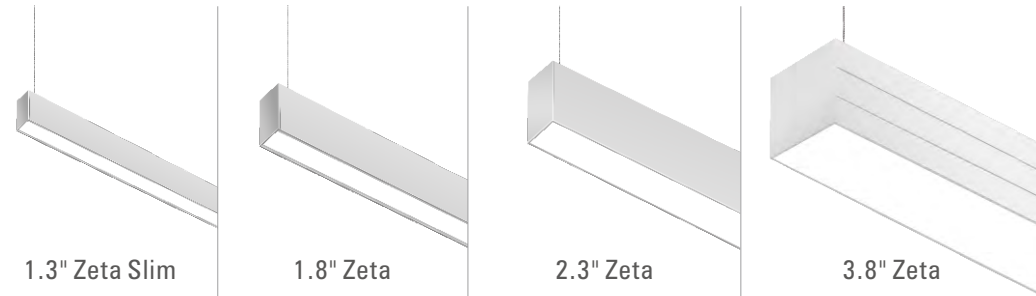

	1.3" Zeta Slim	1.8" Zeta	2.3" Zeta	3.8" Zeta
Width				
Lengths	2', 4', 8'	2', 4', 8'	2', 3', 4', 8'	2', 3', 4', 8'
Optics Efficacy	Diffuser (1050lm/ft) Louver (1200lm/ft) Convex (1100lm/ft)	Diffuser (1050lm/ft)	Diffuser (1050lm/ft) Louver (950lm/ft) Micro Reflector (900lm/ft) Deep Regressed (950lm/ft)	Diffuser (1050lm/ft) Deep Regressed (950lm/ft)
Lighting Distribution	Adjustable by dip switch 25% Up, 75% Down 100% Down	Adjustable by dip switch 25% Up, 75% Down 100% Down	Adjustable by dip switch 100% Up, 90% Up, 10% Down 70% Up, 30% Down 50% Up, 50% Down 30% Up, 70% Down 10% Up, 90% Down 100% Down	Adjustable by dip switch 100% Up, 90% Up, 10% Down 70% Up, 30% Down 50% Up, 50% Down 30% Up, 70% Down 10% Up, 90% Down 100% Down
1-10V Dimming	10% Dimming	10% Dimming	10% Dimming Standard, 1% Dimming Option	10% Dimming Standard, 1% Dimming Option
Mounting	Pendant Surface Wall Mount	Pendant Surface	Pendant Surface Wall Mount Recessed	Pendant Surface Recessed
Joiner	"—" Pattern, "T" Pattern, "L" Pattern, "+" Pattern, "Y" Pattern, "V" Pattern	"—" Pattern, "T" Pattern, "L" Pattern, "+" Pattern, "Y" Pattern, "V" Pattern	"—" Pattern, "T" Pattern, "L" Pattern, "+" Pattern, "Y" Pattern, "V" Pattern, "Z" Pattern	"—" Pattern, "T" Pattern, "L" Pattern, "+" Pattern, "Y" Pattern, "V" Pattern
Wattage Selectable	2': 20w,15w,10w 4': 40w, 30w, 20w 8': 80w, 60w, 40w		2': 20w,15w,10w 3': 30w, 23w, 15w 4': 40w, 30w, 20w 8': 80w, 60w, 40w	
CCT Adjustable	3000K / 3500K / 4000K			
CRI	80+ standard,90+ optional			
Finish	White & Black			
Certificate	UL Listed for damp rated			

Canopy Style

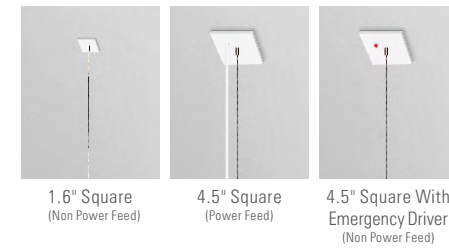
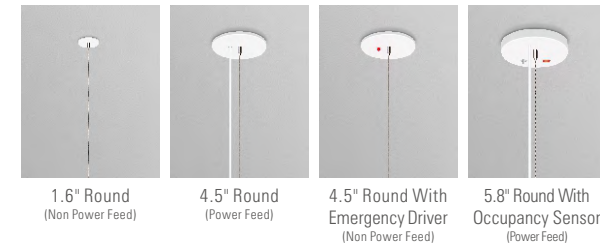

Dry Ceiling / Off Grid



Drop Ceiling / T-Grid Ceiling

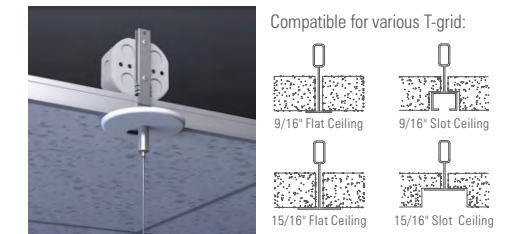

Joiner Options

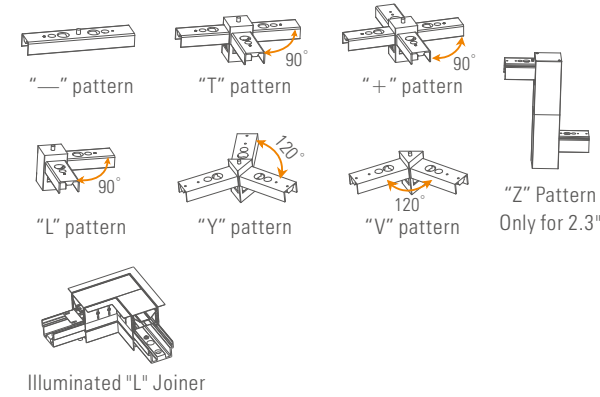

Meta Linear



Meta UP / Down

It is available in 4', 8' lengths, up to 1150lm/ft with CCT adjustable. Transparent edge-lit optics has been designed to deliver and control light for 45% up and 55% down pendant lighting applications, supporting continuous runs.



Meta 24"x24"

Combining clean lines and thin square standalone forms to enhance the decor, it is 24"X24" with up to 90+CRI and 5000lumens, delivering an affordable, stylish architectural solution. The elegant negative space creates a weightless appearance.



Meta Vertical

It is 4', up to 1000lm/ft with ultra-thin semi-transparent vertical optics, enveloped in a signature sloping silhouette, precisely controlled optimal direct and indirect distributions at up to four illuminated sides. It supports continuous runs.



Meta Surface

It is available in 2', 3', 4' lengths and reaching 90+CRI, up to 1300lm/ft with CCT and wattage adjustable. Go for two illuminated sides with ultra-thin semi-transparent vertical optics, it can be suspended, surface and wall mounted.

Meta Up/Down

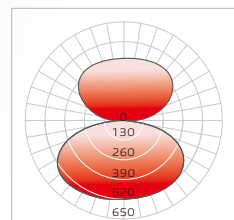

AVERAGE BEAM ANGLE(50%): 360°

Combines brilliant aesthetics with space-filling light

Suspended from the ceiling, this strikingly beautiful luminaire combines brilliant aesthetics with space-filling light. It creates an exceptionally thin profile that appears to float across your ceiling landscape. When turned on, it produces a perfectly even glow, and while off, it is nearly transparent with LEDs hidden inside the frame, which is perfect for applications that include conference rooms, open offices, retail settings, anywhere you want to make a statement.



4' and 8' lengths, up to 1200lm/ft

Semi-transparent optics

55% downlight and
45% uplight distribution

Internal & replaceable driver

CCT adjustable
3000K/ 3500K/ 4000K

Continuous runs



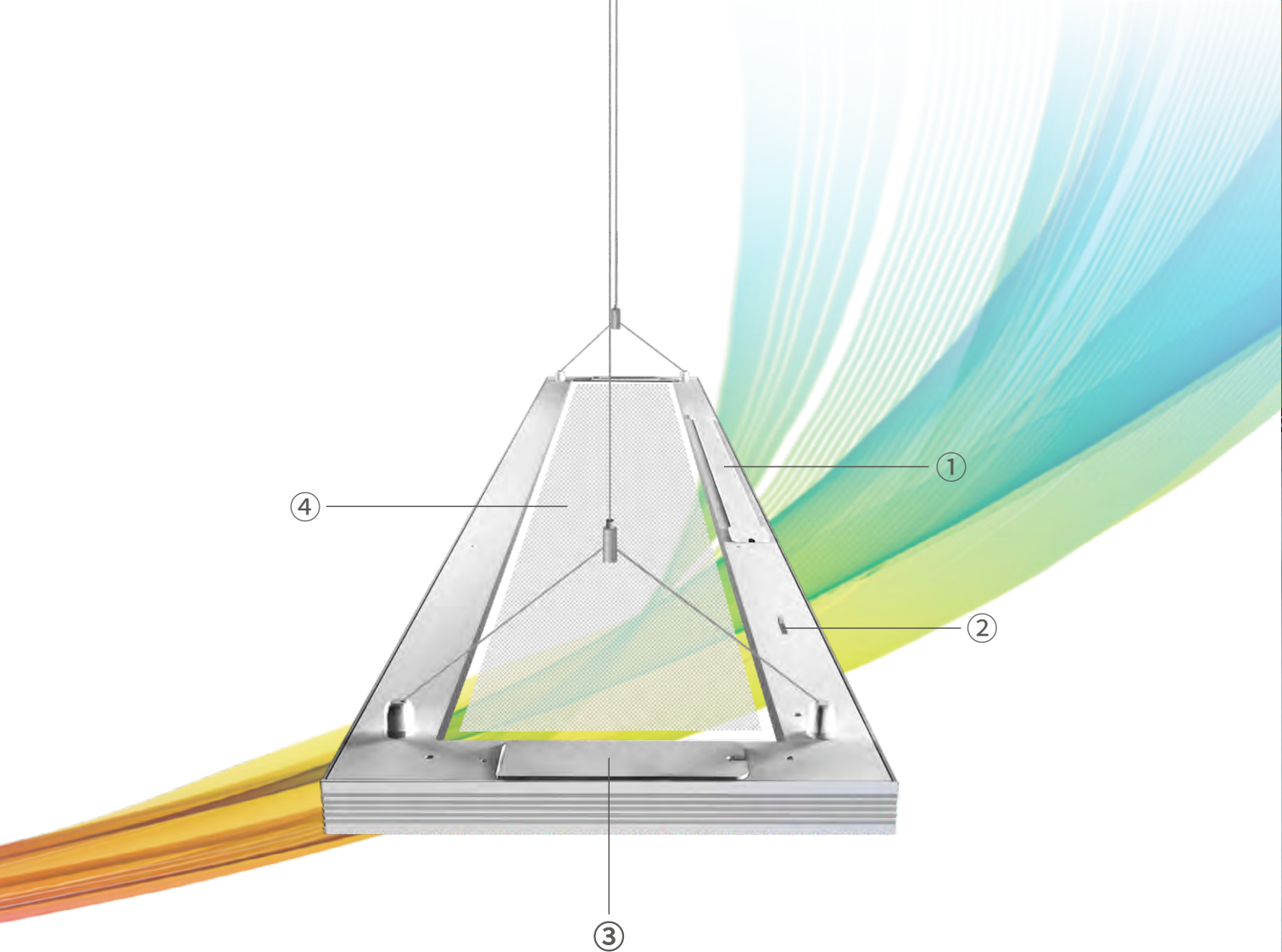

Minimalist Design Maximized Performance

- ① Replaceable Driver**
All drivers are built-in, and can be replaced easily, which is more convenient to maintain.
- ② CCT Adjustable**
Featuring CCT adjustable by using dip switch from 3000K/ 3500K/ 4000K, it can fulfill more orders with fewer SKUs.
- ③ Innovative Joining Design**
Allows for simple and intuitive assembly in the field without tools.
- ④ Semi-transparent Optics**
High precision PMMA light guide, allows to create 45% uplight, 55% downlight light distribution.

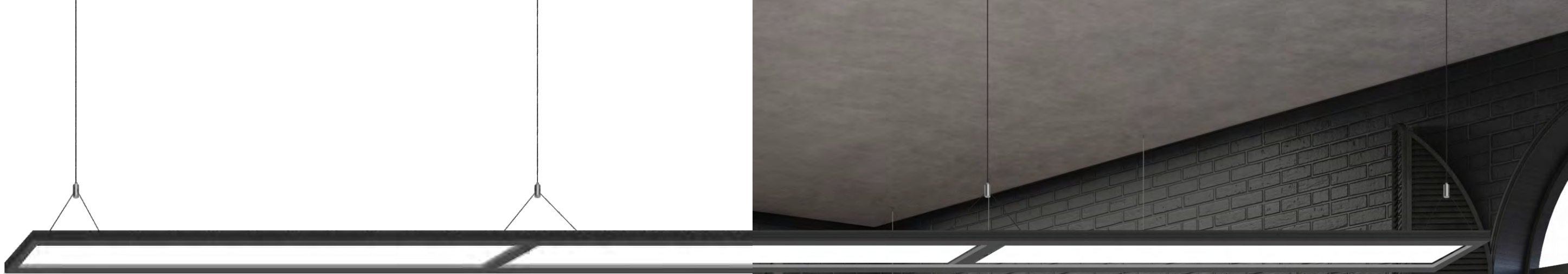

Continuous Runs Create Linear Lighting Atmosphere

It's a highly engineered luminaire, joining design allows for simple and intuitive assembly in the field without tools. Its junction plate ensures that luminaire rows snap into a laser straight line.

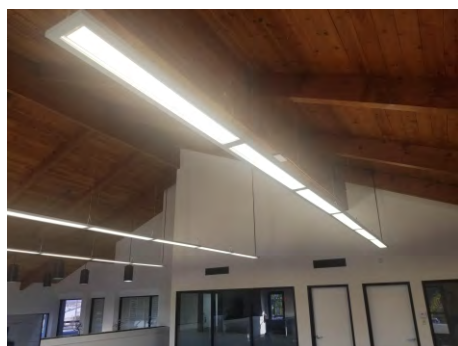

One power can feed multiple lamps to minimize installation time and save labor cost. Runs of luminaires that are up to 80ft in length are designated. This means that the run is comprised of a combination 4ft and/or 8ft sections to be assembled on site using our joining system.

— One power can feed up to 40ft in 120V AC,
80ft in 277V AC

— Dry ceiling or T-Grid ceiling compatible

— Emergency option

— Occupancy sensor option







Meta 24"x24"



Capture the ethereal beauty of illuminated inner space

Meta 24"x24" linear delivers an aesthetic, stylish architectural solution which creates stunning forms only 1.5" high. It combines clean lines and thin, square forms to enhance the decor. Appealing diffuse light is spread over entire surface area of one-piece lens ensuring balanced luminance and visual comfort.

— Semi-transparent optics

— 55% downlight and 45% uplight distribution

— CCT adjustable
3000K/ 3500K/ 4000K

— 50w, 110lm/w



Meta Vertical

A Choice of Design Aesthetic

Combining superior esthetics, quality performance, Meta Vertical offers new opportunities to capture the beauty and benefits of architectural linear lighting. It is integrated with ultra-thin semi-transparent vertical optics, enveloped in a signature sloping silhouette where the frame meets the optics, precisely controlled optimal direct and indirect distributions at a split of light between the direct surfaces below and the ambient area horizontal the fixture.

4' 40W, up to 1100 lm/ft

Transparent vertical optics, enveloped in a signature sloping silhouette

Direct or indirect lighting distribution options

CCT Adjustable 3000K/3500K/4000K

Continuous runs

1 3/10"
7 1/2"





Semi-transparent luminaire when off



Excellent uniformity and efficiency when on



Simplicity Meets Performances

Powerful

When suspended, the Meta Vertical can provide smooth direct or indirect distribution, allowing for wider spacing between fixtures and better ceiling light uniformity.

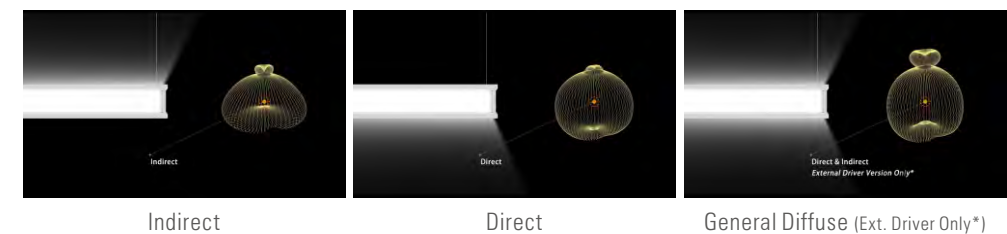

CCT Adjustable

It is a modern luminaire that provides flexibility in how a space is illuminated, featuring independently-selectable color temperatures by using dip switches, you can choose several color temperatures, creating your optimal lighting experience.





Continuous runs Ease of installation

This engineered luminaire joining design allows for simple and intuitive assembly in the field easily which is perfect for high-end applications with seamless lines of light and no pixels or shadows.

- Each power feed connections up to 40ft
- Dry ceiling or T-Grid ceiling compatible
- Emergency option
- Occupancy sensor option

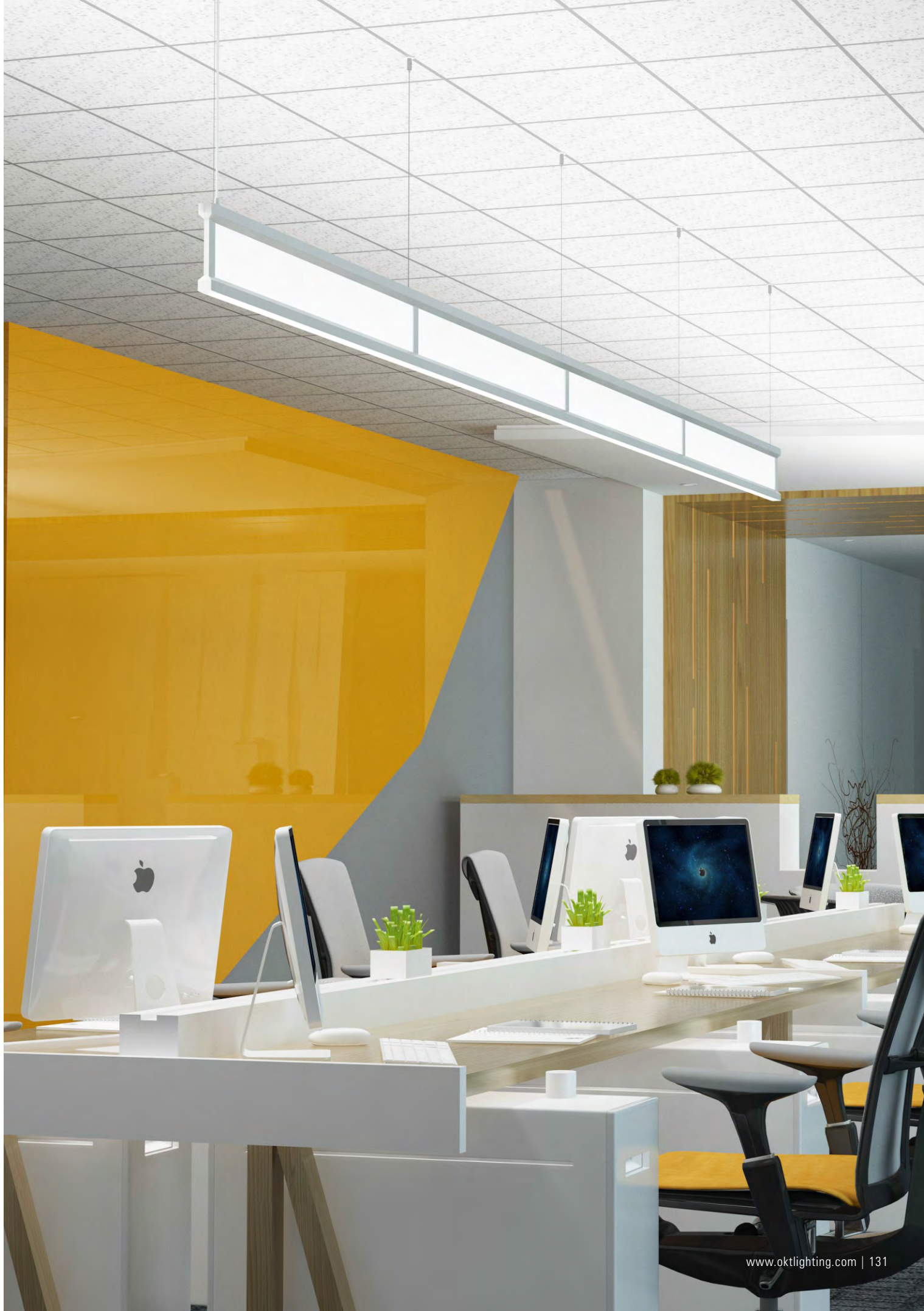



Meta Surface

The Meta Surface's sleek profile is designed to blend into clean, minimalist architectural spaces featuring simple yet powerful lines. It provides a precise blend of high performance and visual comfort by optimizing the transparent optics, perfect for high-end applications. With three options built in-house, Meta Surface makes it easy to get the light where you need it with offering new opportunities to capture the beauty and benefits of true lighting.



Available in 2', 3' and 4'

Up to 1300 lm/ft

Semi-transparent optics

True color, 90+ CRI

CCT & wattage adjustable

Pendant, surface and wall mount options

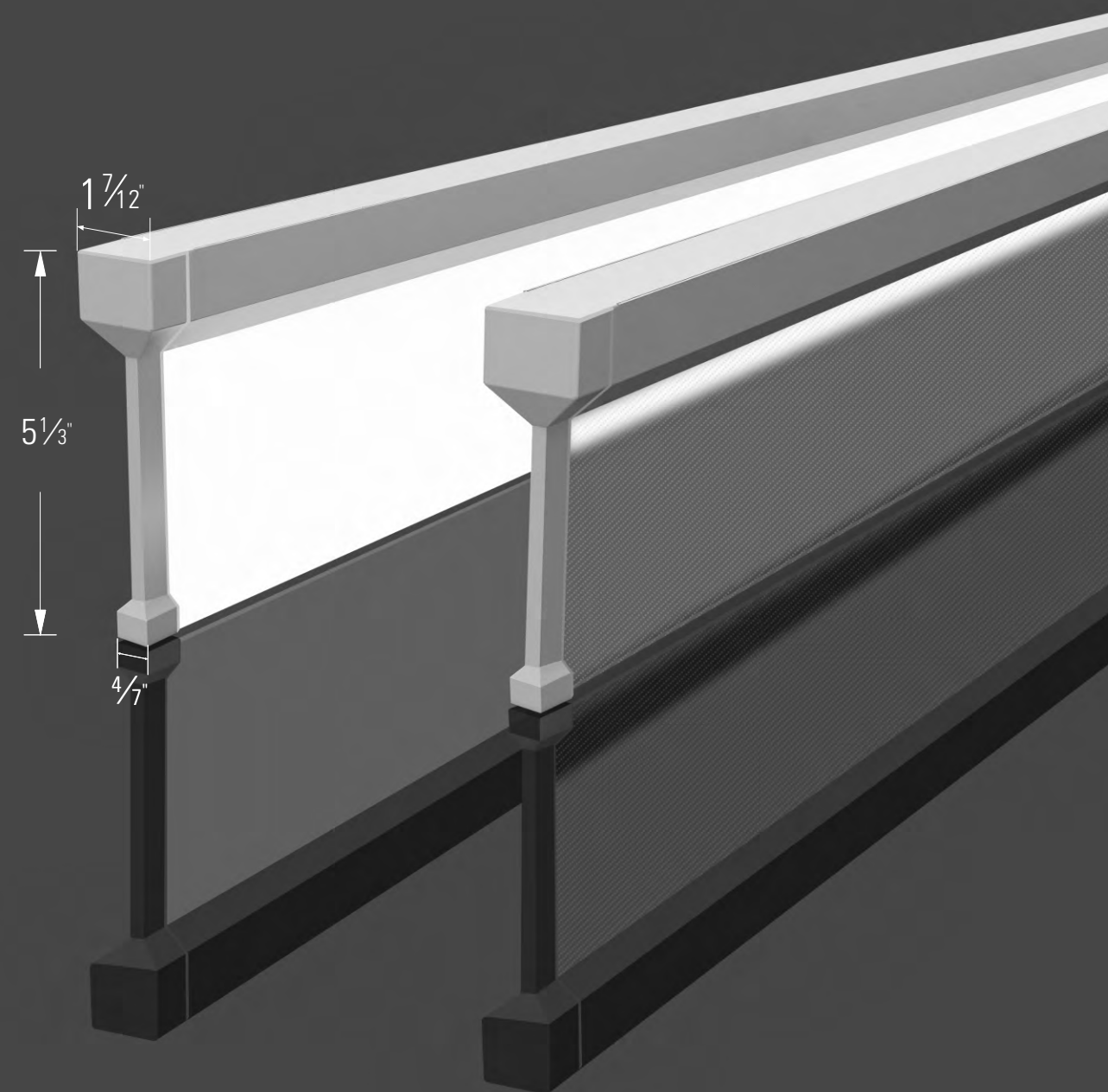
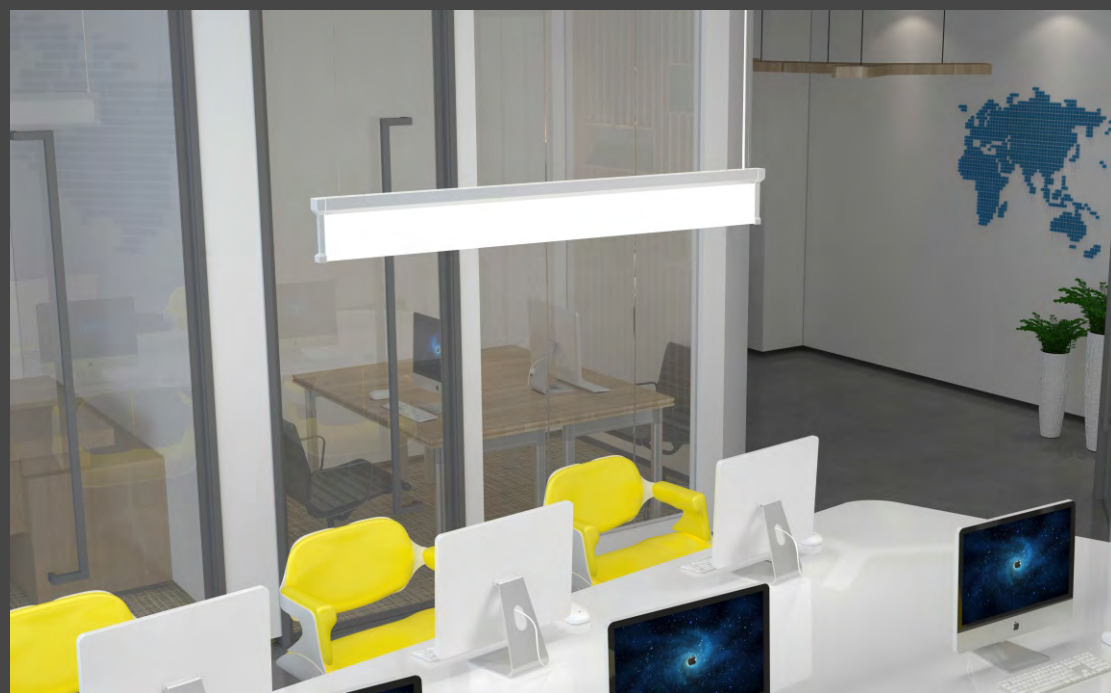

Sleek Profile

1.59" Wide ■ 5.33" Height ■ 23.64"/ 35.43"/47.24" Lengths



Esthetics • Performance • Versatility



Unique design-Transparent optics

It is integrated with ultra thin semi-transparent vertical optics, enveloped in a signature sloping silhouette where the frame meets the optics, precisely controlled optimal direct indirect distributions.

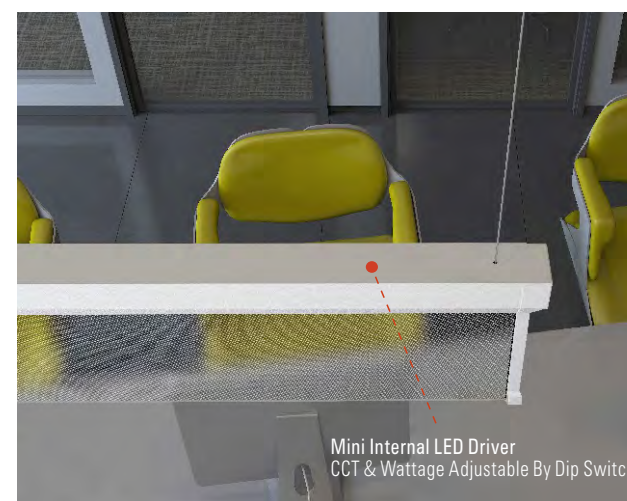

CCT & wattage adjustable

Featuring CCT & Wattage adjustable by dip switches, it is a modern luminaire that provides flexibility in how a space is illuminated with the ultimate control of their spaces.

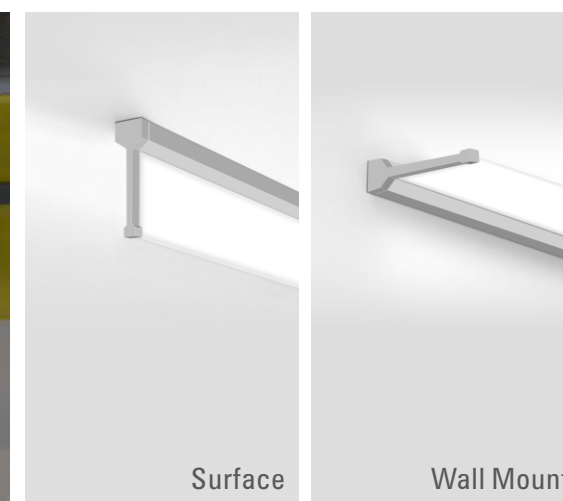

**One clean look,
Three mounting options**

It can be installed with the driver compartment pointing horizontally or vertically, including pendant, surface or wall mount.

Specification-grade

	Meta Up/Down	Meta 24"x24"	Meta Vertical	Meta Surface
Driver	Internal	External	Internal	Internal
Length Wattage	4' 40W 8' 80W	24"x24" 50W	4' 40W	2' 20W 3' 20W/30W/40W selectable 4' 20W/30W/40W selectable
Optics	Transparent PMMA	Transparent PMMA	Transparent PMMA with Diffuser or Louver	Transparent PMMA
Efficacy	1150 lm/ft, 115lm/w	100lm/w	1000 lm/ft, 100lm/w	1000 lm/ft, 100lm/w
Lighting Distribution				
1-10V Dimming	10% Dimming	10% Dimming	10% Dimming	10% Dimming
Mounting	Pendant	Pendant	Pendant	Pendant, Surface Mount, Wall Mount
Continuous Runs	YES	N/A	YES	N/A
Finish	White	White & Black	Silver	White
Certificate	UL listed, DLC qualification	UL listed	UL listed	UL listed DLC qualification
CCT Adjustable	3000K 3500K 4000K			
CRI	80+ standard, 90+ optional			
Input Voltage	110-277V AC Standard, 110-347V AC Option			
Optional Function	Emergency Option (OKT Model#EM-H08170-LBF & EM-H25170-LBF) Sensor Option			
QuickShip	YES			

Dimensions

Meta Vertical



Meta Surface

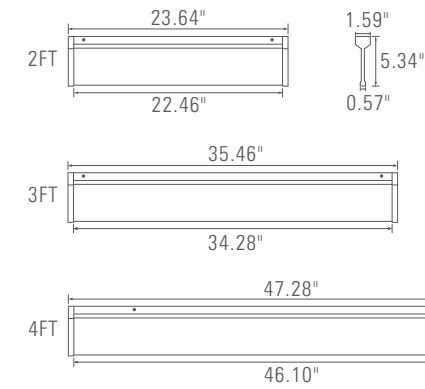

Meta 24"x24"

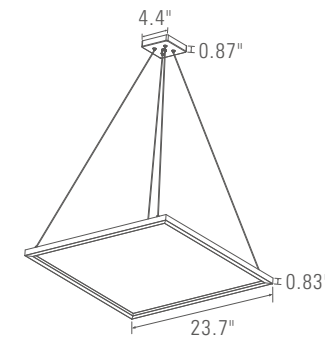

Meta Up/Down

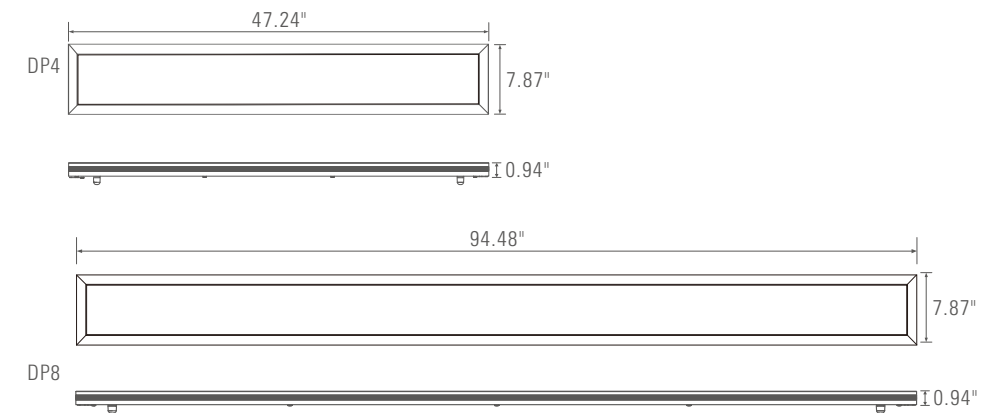

Canopy Style

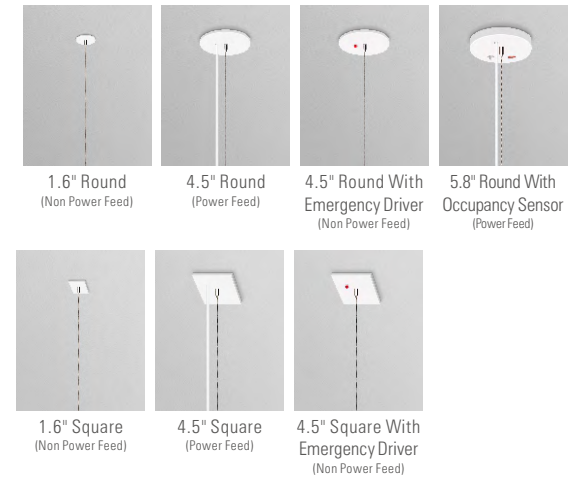

Dry Ceiling / Off Grid

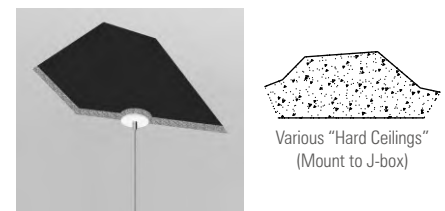

Drop Ceiling / T-Grid Ceiling

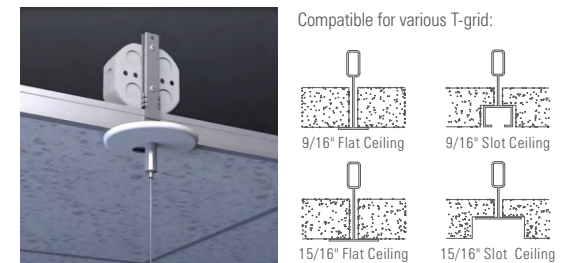



Cylinder



Cylinder Portfolio Design for success

OKT Lighting offers several collections of architectural cylinder that can add rhythm, beauty and creativity to the ceiling plane. With their sexy aesthetics and uniform soft illumination, they allow you to enhance modern interiors, including offices, restaurants, hotels and high-end residential projects.





Endless possibilities for designs throughout your spaces

These models blend timeless aesthetics and high-performance COB LED to create pleasant, uniformly illuminated indoor environments.

Engineered for superior visual comfort, they come in a variety of beam options, with a full range of trim and mounting options. Our collection of cylinders ensure a high level of lighting design flexibility in commercial and institutional applications.

Modular Design: up to 100,000 unique combinations

COB LED Chip: 80+ or 90+ CRI option

Beam Angle : 15°, 24°, 36°, 60° options

Architectural Form : 4", 6" and 8" with multiple trim

Wattage Selectable: 90~105 lm/w

Dimming: 0-10V (10% standard, 1% option) or TRIAC

Mounting : pendant or surface

Over 100,000 options, configurable in seconds

Whether you need pendants in a specific finish or surface mount in a certain trims, we have you covered. With our user-friendly ordering guide, you can try out every combination according to your space required.



Modular design

OKT's cylinder would greatly help maintain consistency and create possibilities in the whole commercial area which make light modular with multiple mounting ways, interchangeable optics, and high visual-comfort reflectors as its standard configuration.

Engine

4"	6"	8"
15W/20W/25W	27W/36W/45W	36W/48W/60W

Optics

15° 24° 36° 60°	

Trims

- Standard
 -
 -
- Decorative
 -
 -
 -
 -
 -
- 12" Regress Trim (Only for 4" Cylinder)
 -
 -



A Winning Combination



Add visual interest while ensuring uniformly illuminated

Architectural LED Cylinder Family At A Glance

OKT Lighting offers numerous cylinder lighting options that complement our pendant and surface mounted lighting platform, while providing a consistent aesthetic. Performance and beauty are both in play with our sleek and sexy architectural cylinders.

White Exterior Finishes



Black Exterior Finishes



Engineered for beauty and performance

OKT's CY cylinders are a collection of visually attractive LED luminaires with high performance, value, modularity and elegance while delivering superior visual comfort and daylight-inspired illumination. Each details offer distinct advantages.



COB LED with a 80+ is standard. 90 CRI is also available



Wattage selcectable by dip switch from 100%/75%/50%



2700K, 3000K,3500K and 4000K CCT options



TRIAC or 0-10V dimming. Dim to 10% is standard and 1% is optional.



Up to 5000lm, 90~105lm/w

Optics Challenge

The optics range has been expanded to 4 beam angle options. These beamsreads are interchangeable which can be easily swapped out in the field without tools, providing more flexibility in the design.

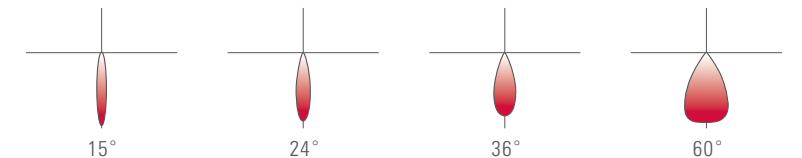



Mounting Option

Pendant



Cable Mount
4"

Cable Mount
6" / 8"

Rigid Pendant
Stem Mount
4" / 6" / 8"



Cable Mount
4"

Cable Mount
6" / 8"

Rigid Pendant
Stem Mount
4" / 6" / 8"

Ultimate Field Flexibility

OKT's cylinder form factor is now available in pendant and surface mount configurations which offers a beautiful, decorative solution with beautifully anodized white, black finishes while delivering high performance.

Surface



4" / 6" / 8"

4"

6"

8"

A SOLUTION FOR EXPOSED OPEN CEILING

OKT's cylinder is specifically designed for use with surface mounted conduit and junction boxes on ceilings where recessed lighting is not possible. Perfect for lofts, offices, and open architectural spaces.

If standard 4" octagonal J-box is surface mounted, a Ø5.97" round x 2.38" deep canopy with conduit cutout is provided for mounting. Conduit cutout canopy has 4 key slots, one in each side, and can be configured to accommodate any ceiling layout using 1/2" or 3/8" conduit. Conduit cutout canopy is provided white and black powder coat painted finish.

Conduit Cutout Deep Canopy For Surface Mount J-box

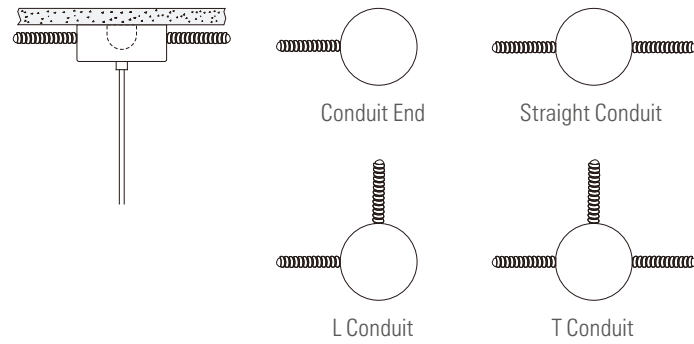

CYLINDER, SURFACE MOUNTED

Available in a complementary surface mounted version, CY series allow designers to maintain aesthetic continuity throughout a space. It is the ideal choice for low ceilings and minimal ceiling spaces.

Mounting Option

Surface Mounted To Recessed J-Box



4" / 6" / 8"

Surface Mounted Conduit Cutout To Surface J-Box



4"

6"

8"











Designed for use with surface mounted conduit and junction boxes on ceilings



A delicate dance of high performance, value, modularity and elegance



Specification-grade

	 4" Cylinder	 6" Cylinder	 8" Cylinder
Mounting	Pendant with cable kit Pendant with rigid stem Surface mount	Pendant with aircraft cable Pendant with rigid stem Surface mount	Pendant with aircraft cable Pendant with rigid stem Surface mount
Wattage Selectable	12W/18W/25W	20W/30W/40W	30W/45W/58W
Efficacy	95lm/w	105lm/w	90lm/w
Lumens	Up to 2350lm	Up to 4200lm	Up to 5220lm
LED	COB		
CCT Option	2700K/3000K/4000K/5000K		
Beam Angle	15°/24°/36°/60°		
CRI	80+ or 90+		
Dimming	10% Dimming Standard, 1% Dimming or TRIAC Dimming Option		
Trim Options	<ul style="list-style-type: none"> • Standard 	<ul style="list-style-type: none"> • Decorative 	<ul style="list-style-type: none"> • 12" Regress Trim (Only for 4" Cylinder) 
Finish	White & Black		
Certificate	UL Listed for damp rated		

Surface Lighting Solutions

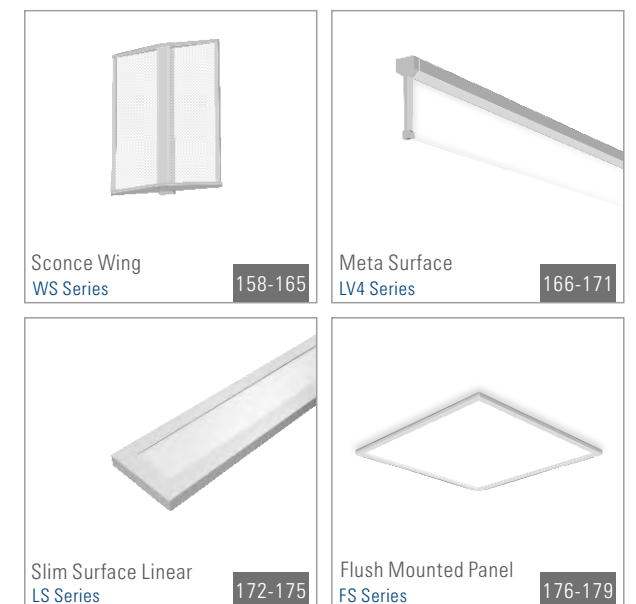

Sconce Wing

5 CCT
Select



Gives new meaning to lighting aesthetic

Sconce Wing brings a new dimension to architectural wall lighting. It provides low-level lighting when daytime transitions to evening. Additionally, It can be wall or surface mounted and add a layer of light on the walls that feels less institutional, to soften facility ambiance and enable interior design cohesiveness. This innovative design brings both performance and aesthetics to any design applications.

90+ CRI

3 CCT adjustable
3000K/ 3500K/ 4000K

Wattage selectable

Ultra-thin transparent optics

0-10V dim, 10% standard, 1% option

12", 18" and 24" length options for wall mount or surface, 48" for suspended





Sconce Wing

Performance

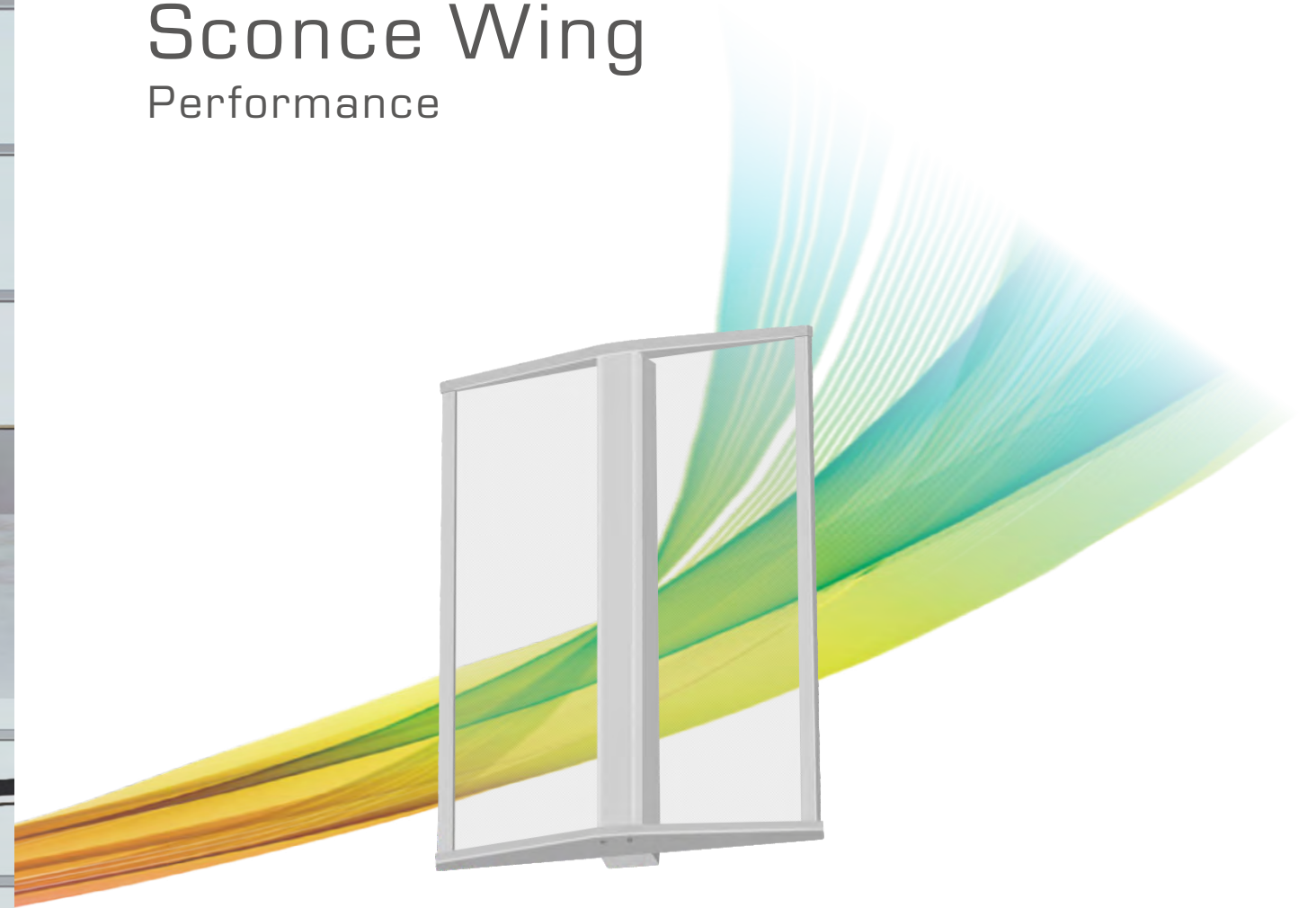

Combining superior esthetics, quality performance, and flexible mounting, Sconce Wing offers new opportunities to capture the beauty and benefits of architectural linear lighting. It has four sizes with wattage and CCT adjustable for scalability. The sleek profile is designed to blend into clean, minimalist architectural spaces. Easy install in the field which is perfect for applications that include corridor, open offices, hospital, anywhere you want to make a statement.

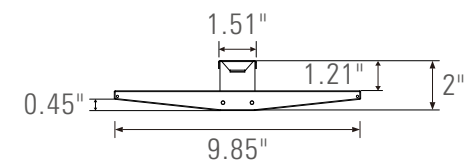

90+ CRI

True color, We strive to challenge the highest visual comfort.

Wattage Selectable

Maximum 20W or 40W with wattage selectable from 100%/75%/50% by dip switch. Fulfill more orders with fewer SKUs.

CCT Adjustable

Tunable white from 3000K, 3500K, 4000K. Maximize light compatibility by dip switch.





Specification-grade

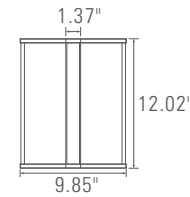

Length	12"
Wattage Selectable	10W / 15W / 20W
Efficacy	88LM/W
CCT Adjustable	3000K 3500K 4000K
Input Voltage	110-277V AC Standard 110-347V AC Option
CRI	90+
Mounting	Wall Mount, Surface



Length	18"
Wattage Selectable	10W / 15W / 20W
Efficacy	88LM/W
CCT Adjustable	3000K 3500K 4000K
Input Voltage	110-277V AC Standard 110-347V AC Option
CRI	90+
Mounting	Wall Mount, Surface

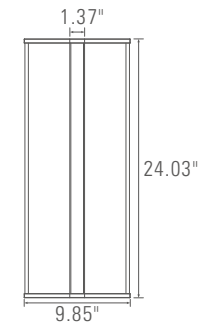

Length	24"
Wattage Selectable	10W / 15W / 20W
Efficacy	88LM/W
CCT Adjustable	3000K 3500K 4000K
Input Voltage	110-277V AC Standard 110-347V AC Option
CRI	90+
Mounting	Wall Mount, Surface

Length	48"
Wattage Selectable	20W / 30W / 40W
Efficacy	88LM/W
CCT Adjustable	3000K 3500K 4000K
Input Voltage	110-277V AC Standard 110-347V AC Option
CRI	90+
Mounting	Suspended

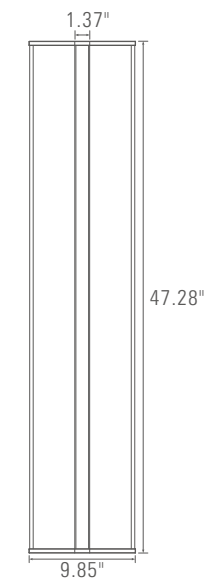

Meta Surface

A Step Forward In Ambient Interior Illumination

The Meta Surface's sleek profile is designed to blend into clean, minimalist architectural spaces featuring simple yet powerful lines. It enables designers to mount the luminaires on walls and ceilings to enhance architectural styling or add a unique flair to the interior design of a space. With three options built in house, Meta Surface makes it easy to get the light where you need it with offering new opportunities to capture the beauty and benefits of true lighting.



Available in 2', 3' and 4'

Up to 1300 lm/ft

Semi-transparent optics

True color, 90+ CRI

CCT & wattage adjustable

Surface and wall mount
Pendant option



1 7/12"
5 1/3"
4/7"





Surface

It is attractive and easy to install with simple screws or threaded studs which pass through the housing to fasten the luminaire in place. Ideal for locations with low ceilings or where fire ratings prevent recessed luminaires.



Wall Mount

It is available in a surface reverted design, with a sleek low-profile sensibility optimal for architectural lighting applications without any wall mount bracket, allows for easy installation, ideal for corridors, stairwells, and more.

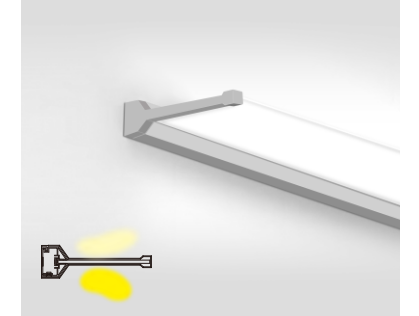



Specification-grade

Length	Length	Length
2'	3'	4'
Wattage	Wattage	Wattage
20W	40W/30W/20W	40W/30W/20W
Efficacy	Efficacy	Efficacy
1000lm/ft	1300lm/ft	1000lm/ft
CCT Adjustable	CCT Adjustable	CCT Adjustable
3000K 3500K 4000K	3000K 3500K 4000K	3000K 3500K 4000K
Input Voltage	Input Voltage	Input Voltage
110-277V AC Standard 110-347V AC Option	110-277V AC Standard 110-347V AC Option	110-277V AC Standard 110-347V AC Option

LED
 CRI: 90 +
 Lifetime: > 50,000H L70 minimum

Driver
 THD < 20%
 Power Factor > 0.90
 Internal Driver
 1-10V , 10% dimming standard
 Tested Dimmers: Lutron® Diva-Dvtv, Leviton® IP-710-DL

General
 Finish: White
 Materials: Extruded Aluminum
 Listings: UL, DLC Qualification
 Application: Damp rated
 Warranty: 5 Years Limited
 Mounting: Surface, Wall Mount and Suspended options

Function Options
 Emergency Option (OKT Model#EM-H08170-LBF)

Dimensions

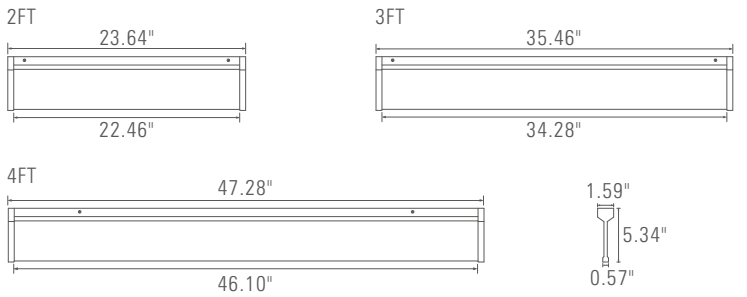

Slim Surface Linear

Low
Profile



— Low profile

— Built-in driver

— Available in 4", 6" width and 2', 4' length

— CCT & wattage adjustable

— Available in surface mounted and recessed



Performance

- ① **Built-in driver, ultra-thin profile**
It is integrated with surface mounted and recessed with built-in driver. Only 0.94" thickness makes it able to be installed the LED light just about anywhere.



- ② **CCT and wattage adjustable**
Most of our customers have been struggling with inventory control, thanks to the CCT and wattage adjustable technology, you can now fulfill more orders with fewer SKUs! Configure 18 options with only 6 SKUs
 - Wattage selectable (50%/75%/100%)
 - CCT adjustable from 3000K, 3500K and 4000K

- ③ **Easy mounting**
This metal plate is equipped with screw holes for bolting to the ceiling, with dimensions of 4" x 2', 4" x 4', 6" x 2', 6" x 4'.



Surface Mounted Kit



Flush Mounted Panel



Air Surfaced, New Fashion

It is an integrated lighting solution that compliments the ceiling and entire space while providing comfortable general illumination with reaching up to 110lm/w. The unique internal driver and only 0.68" thickness allow you the ability to install the LED light just about anywhere, especially for the small and confined space, including surface mounted, recessed and suspended installations methods.

Low profile

2'x2', 2'x4, 1'x4' size options

Ultra thin surface design,
0.68" thickness

110lm/w DLC Standard

Wattage selectable

CCT adjustable 3000K/4000K/5000K





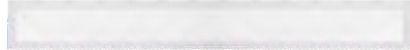

Specification-grade

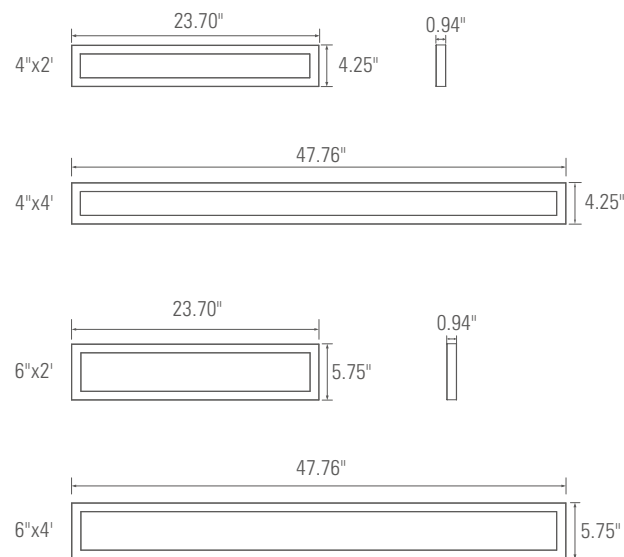
				
Dimension	4"X2'	4"X4'	6"X2'	6"X4'
Wattage	20W	20W/30W/40W Selectable	20W	20W/30W/40W Selectable
Efficacy	85lm/w	85lm/w	90lm/w	100lm/w
Lumens	Up to 1700lm	Up to 3400lm	Up to 1800lm	Up to 4000lm
CCT Adjustable	3000K/3500/4000K adjustable			
Mounting	Surface mount, Recessed			
Driver	Internal, 100-277VAC			
CRI	80+ standard, 90+ optional			
Dimming	1-10V, 10% Dimming			
Finish	Alpine White			
Certificate	UL Listed			
Optional Function	Emergency Option (OKT Model#EM-H08170-LBF)			
Flange Kit	YES			
QuickShip	N/A	YES	N/A	YES

Dimension



								
Dimension	1'X1'	1'X2'	1'X4'	2'X2'	2'X4'			
Wattage	18W	25W	20W/30W/40W Selectable	20W/30W/40W Selectable	30W/40W/50W Selectable			
Efficacy	95lm/w	100lm/w	110lm/w	110lm/w	110lm/w			
Lumens	Up to 1700lm	Up to 2500lm	Up to 4400lm	Up to 4400lm	Up to 5500lm			
CCT Adjustable	N/A	N/A	3000K/4000K/5000K adjustable					
Mounting	Surface mount, Recessed			Surface mount, Recessed, Suspended				
Driver	Internal, 100-277VAC							
CRI	80+ standard, 90+ optional							
Dimming	1-10V, 10% Dimming							
Finish	Alpine White							
Certificate	UL Listed			UL Listed, DLC Qualification				
Optional Function	Emergency Option (OKT Model#EM-H08170-LBF)							
QuickShip	N/A			YES				

Dimension

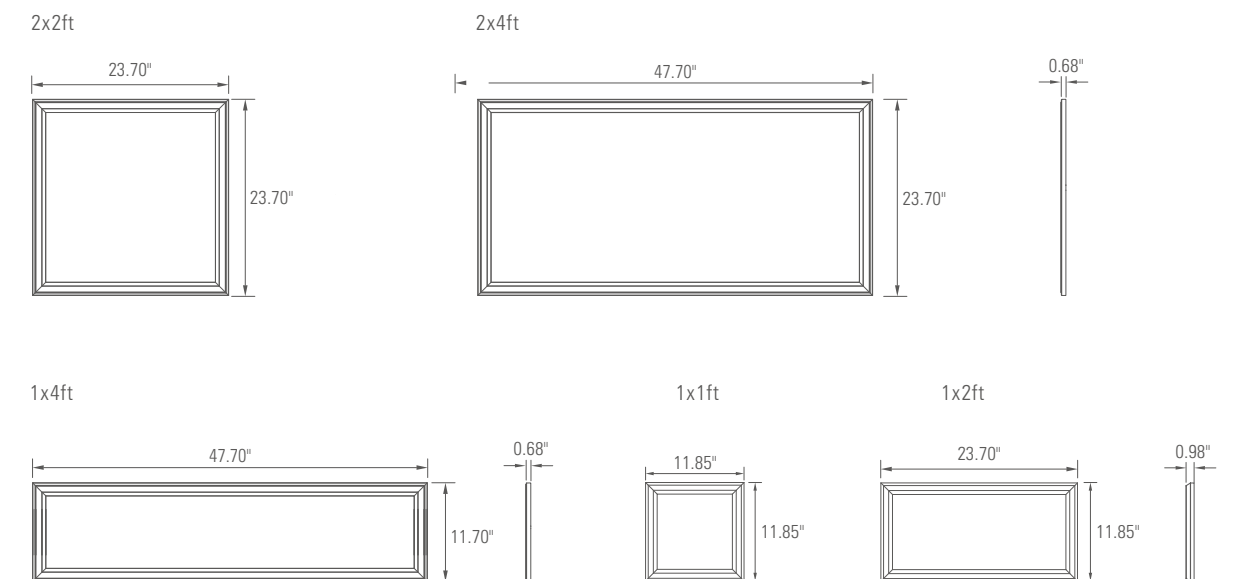

Emergency Lighting Solutions



LED Emergency Driver
EM-Series

181-191



WHY OKT?

OKT is known for quality LED emergency driver manufacturer in North America. The 3rd Gen EM is a statement to show our customers OKT's innovation spirit. Every year, we bring you exciting upgrades!

10 Years Experience Since 2013
Upgraded To Gen 3

Widely Used And Quality Assurance
UL, CEC Certified

Wide Compatibility
Unrivalled Emergency Solution
For Any Up To 300w LED Luminaire

Keep Moving
Be The Specialist



No Delays When Power Fails!



A simple equation for LED product

OKT offers UL Listed, field-installable, emergency LED drivers. All of the OKT LED emergency driver portfolio is UL listed for installation in the field that simplify the process for field installation by eliminating the time consuming measures required by a Classified listing. And OKT was the first Chinese manufacturer to offer field-installable emergency LED drivers for the U.S. Choosing the appropriate emergency driver solution starts with your luminaires.

Operation

When AC power failed EM Series will immediately switches to the emergency mode, operating for a minimum of 90 minutes. When AC power is restored, the emergency driver then will automatically switch to the charging mode.

UL and CEC Listed, field-installable

Compatible for most LED products

Simplify installation

High-quality Lithium battery,
Discharge capacity at the 300th cycle
≥ 80% of initial capacity

Up to 120 minutes when power fails

Monthly auto test function for
reduced maintenance

Pre-install service available

Full Ranges

Emergency lighting is a vital part of a facility's life safety program. Local, state and national building codes require reliable and sufficient emergency illumination for commercial, industrial and institutional buildings in the United States. When normal power fails for any reason, emergency lighting provides critical illumination. It helps to guide building occupants along the path of egress to the nearest exit.



Pack-High Voltage *EM-H Series*

- Output Power 8W, 25W
- Output Voltage 170V DC
- More compatible
- Used on any 1~200W LED luminaire with 0-10V dimming. Including LED downlight, suspended linear luminaire, T8 LED tube, etc.



Pack-Low Voltage *EM-L Series*

- Output Power 8W, 25W
- Output Voltage 15-54V DC
- Easier wiring
- Used on up to 300w led luminaire that driver's output is able to do wiring, like LED troffer, edge-lit LED panels, recessed linear luminaire, etc.

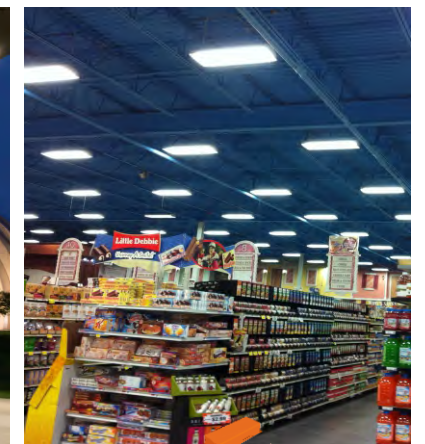

Split-Low Voltage *EM-S Series*

- Output Power 8W
- Output Voltage 15-54V DC
- More flexible
- Ideally to used inside the LED luminaire (100w max), like LED troffer, linear high bay, tri-proof light, etc.

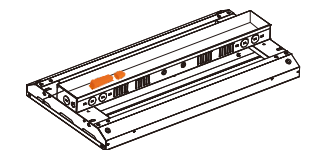

Code Required Testing

More secure, more rigorous than the standard requirements.

- **Initial Self-Test After Installation**

It will perform a functional test in 3 seconds after the driver installed to check the wiring and battery output when work. The indicator LED will be off or flicker in case of a failure or an error.

- **Second Self-Test In 120 Minutes**

It will perform second test in 120 minutes to check again. Upgrade in Gen 3: Repeat 4 times in every 120 minutes if fail in the second test.

- **Monthly Self-Test**

It will automatically perform a test every 30 days with a duration of 3 seconds, in which the wiring and battery output are checked. In case of a failure or an error, the indicator LED will be off or flicker.

Multiple Mounting Configurations

OKT emergency LED drivers work in conjunction with LED fixtures to serve as code-compliant emergency lighting sources. The emergency drivers can be installed inside, on top of, or remotely from the fixture, depending on the product, fixture and application.

Dual Flex (Standard)

Provides dual flex for wiring to both the fixture or driver compartment and test accessories.



Single Flex (Optional)

Mounts to the junction box and provides flexible conduit for remote mounting of the test accessories.



Integral Non-Flex (Optional)

Allows for integral installation within the driver compartment. May also be mounted atop the fixture when used with a TMK cover accessory.



Top-Mount Non-Flex (Optional)

Top-mounting option for running wires directly into the driver compartment. Test accessories are then installed within the fixture.



Field Installation

OKT offers UL listed, field-installable, emergency LED drivers. All of the OKT LED driver portfolio is UL listed for installation in the field.

Benefits:

- ▶ Eliminate factory installed up charges.
- ▶ Eliminate the legwork involved in the field-install process associated with UL Classified emergency LED drivers.



Indicator

- Indicator Reached LELV Rated Output
- Suitable for wet location and applied to outdoor application
- 2-Wire Illuminated Test Switch

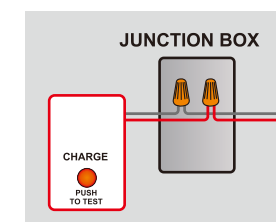

Two-wire illuminated test switch (2w-ITS)

Specification-grade

Low Voltage - Pack



EM-L0854-LBF
Output Power
8 Watts
Output Voltage
15-54V DC
Input Current
70 mA (Max)
Input Power
3.2 Watts (Max)
Input Voltage
100-277VAC, 50-60Hz
Emergency Operation
≥ 90 Minutes
Standby Power
< 0.4W
Operating Temp
0°C to 50°C
Battery
Lithium
Recharge
24 Hrs
Luminaire Load Power
100W (Max)
Dimensions
L10.64"×W1.98"×H1.32"
Certificate
UL , CEC
Output Class
UL LELV (Output protection self-resetting)
Note
<ul style="list-style-type: none"> Low voltage emergency driver is suitable to backup the led fixtures that driver's output is able to do wiring. Power of LED fixture (Up to 100W) ≥ Power of emergency driver. LED Driver Output Current: 5A Max



EM-L2554-LBF
Output Power
25 Watts
Output Voltage
18-54V DC
Input Current
110 mA (Max)
Input Power
6 Watts (Max)
Input Voltage
100-277VAC, 50-60Hz
Emergency Operation
≥ 90 Minutes
Standby Power
< 0.4W
Operating Temp
0°C to 50°C
Battery
Lithium
Recharge
36 Hrs
Luminaire Load Power
300W (Max)
Dimensions
L15.4"×W2.13"×H1.57"
Certificate
UL , CEC
Output Class
UL LELV (Output protection self-resetting)
Note
<ul style="list-style-type: none"> Low voltage emergency driver is suitable to backup the led fixtures that driver's output is able to do wiring. Power of LED fixture (Max 300W) ≥ Power of emergency driver.

Low Voltage - Split

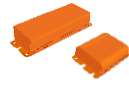

EM-S0854-LBN
Output Power
8 Watts
Output Voltage
15-54V DC
Input Current
70 mA (Max)
Input Power
3.2 Watts (Max)
Input Voltage
100-277VAC, 50-60Hz
Emergency Operation
≥ 90 Minutes
Standby Power
< 0.4W
Operating Temp
0°C to 50°C
Battery
Lithium
Recharge
24 Hrs
Luminaire Load Power
100W (Max)
Dimensions
Driver: L5.08"×W2.05"×H0.99" Battery: L3.47"×W2.33"×H0.97"
Certificate
UL , CEC
Output Class
UL LELV (Output protection self-resetting)
Note
<ul style="list-style-type: none"> It works with LED fixtures for which wiring is accessible to LED module. Power of LED fixture ≥ Power of emergency driver. LED Driver Output Current: 5A Max

High Voltage - Pack



EM-H08170-LBF
Output Power
8 Watts
Output Voltage
170V DC
Input Current
70 mA (Max)
Input Power
3.2 Watts (Max)
Input Voltage
100-277VAC, 50-60Hz
Emergency Operation
≥ 90 Minutes
Standby Power
< 0.4W
Operating Temp
0°C to 50°C
Battery
Lithium
Recharge
24 Hrs
Luminaire Load Power
60W (Max) Minimum dim-down power ≤ EM power
Dimensions
L12.76"×W2.13"×H1.57"
Certificate
UL , CEC



EM-H25170-LBF
Output Power
25 Watts
Output Voltage
170V DC
Input Current
110 mA (Max)
Input Power
6 Watts (Max)
Input Voltage
100-277VAC, 50-60Hz
Emergency Operation
≥ 90 Minutes
Standby Power
< 0.4W
Operating Temp
0°C to 50°C
Battery
Lithium
Recharge
36 Hrs
Luminaire Load Power
200W (Max) Minimum dim-down power ≤ EM power
Dimensions
L15.4"×W2.13"×H1.57"
Certificate
UL , CEC

Note

High Voltage

Situation 1) Without 0-10V dimming function

- EM-H08170– Compatible for ≤8W LED luminaire with internal driver.
- EM-H25170– Compatible for ≤25W LED luminaire with internal driver.

Situation 2) With 0-10V dimming function

- Minimum Dim-down Power ≤ Output Power of LED emergency driver.
- Recommended Compatibility:
EM-H08170– Compatible for up to 60w LED luminaire with 0-10V dimming.
EM-H25170– Compatible for up to 200w LED luminaire with 0-10V dimming.

Optional Indicator



Standard
Fix the indicator light on to the ceiling with nut.



Recessed
Install the indicator light to the opening hole and fix it and J-box onto the ceiling with the nut.

Optional Install Kit



T-Grid Hanger
It is safer to mount the LED emergency driver on the T-grid ceiling.



Blank page with horizontal dashed lines for writing.

Blank page with horizontal dashed lines for writing.

Blank page with horizontal dashed lines for writing.

Blank page with horizontal dashed lines for writing.

