

IMPORTANT

1. Read all instructions.
2. Install in accordance with national and local electrical code regulations.
3. This product is intended to be installed and serviced by a qualified, licensed electrician.
4. Do not install in wet locations. For dry and damp use only.
5. Turn off electrical power before installing or servicing fixture in any way.
6. To reduce the risk of fire and overheating, make sure all connections are tight.
7. Under no circumstances can the lighting fixture be covered with heat insulation gasket or similar materials.
8. The maximum connection of each input line is less than 40FT(1200CM) in 120AC, less than 80FT (2400CM) in 230AC, less than 100FT(3000CM) in 277AC.

WIRING DIAGRAM

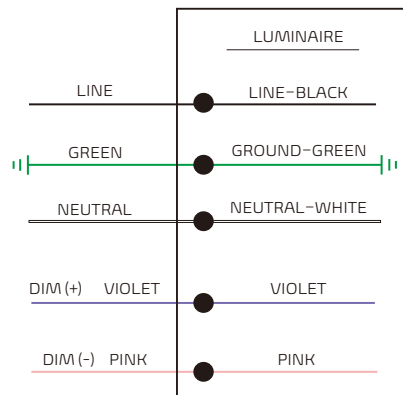

ATTENTION

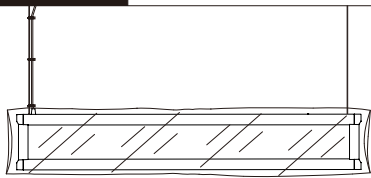

1. Leave the protective bag and protective films on the fixtures until construction and furniture are complete.
2. Fixture can be operated as normal with the bag on.



SHOCK HAZARD!

May result in serious injury or death.
Turn power OFF at circuit breaker prior to installation or servicing.

POWER FEED

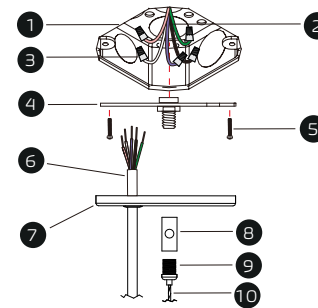

PARTS LIST

- 1 4" Octagon Junction Box (By Others)
- 2 Power Cord (By Others)
- 3 Wire Nut
- 4 Junction Box Crossbar
- 5 Screw PM4*22
- 6 Power Cord
- 7 4" Power Canopy Kit
- 8 Cable Holder
- 9 Strain Relief Thread Nut
- 10 Aircraft Cable
- 11 Drywall Ceiling (By Others)
- 12 Butterfly Drywall Anchor
- 13 Crimp Stud
- 14 2" Canopy
- 15 Solid Ceiling (By Others)
- 16 Anchor
- 17 Screw PA4*30

WARNING:

RISK OF FIRE AND ELECTRICAL SHOCK. FIXTURE MUST BE INSTALLED BY A QUALIFIED ELECTRICIAN ONLY IN ACCORDANCE WITH NATIONAL, LOCAL BUILDING AND ELECTRICAL CODES. DISCONNECT POWER AT ELECTRICAL PANEL BEFORE SERVICING.

NON POWER SUSPENSION

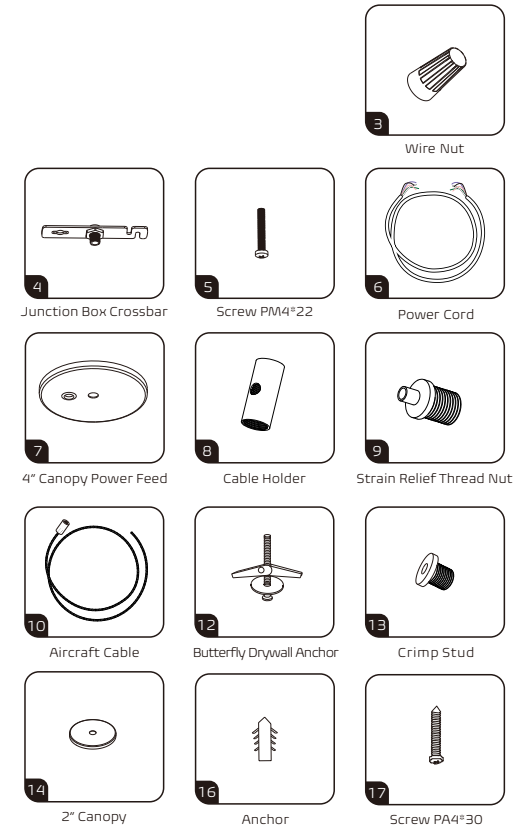
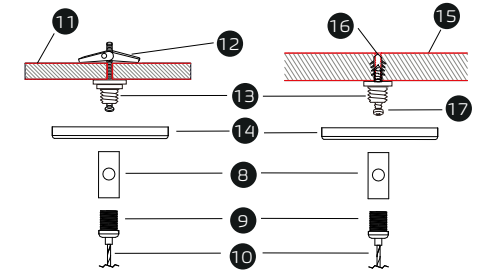

DROP CEILING - T-GRID CLIPS

VERTICAL LED LUMINAIRE Internal Driver Version

POWER FEED

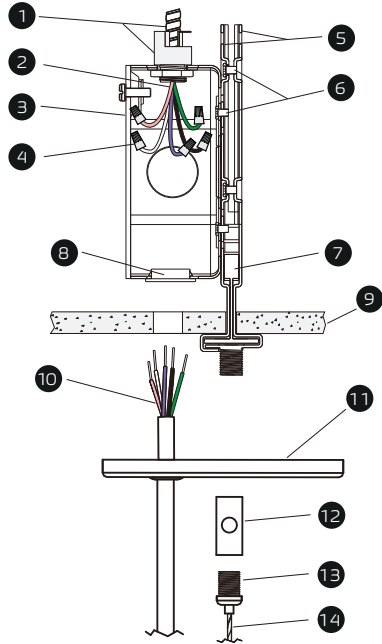

NON POWER SUSPENSION

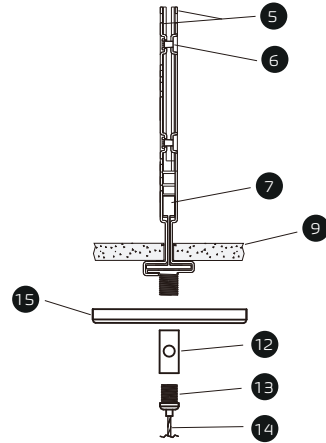

PARTS LIST

- 1 Armored Cable & Connector (By Others)
- 2 Power Cord (By Others)
- 3 4" Octagon Junction Box
- 4 Wire Nut
- 5 Assembled T-grid Clips
- 6 Screw 6#*4
- 7 T-grid (By Others)
- 8 Plastic Grommet
- 9 Ceiling Tile (By Others)
- 10 Power Cord
- 11 4" Canopy Power Feed
- 12 Cable Holder
- 13 Strain Relief Thread Nut
- 14 Aircraft Cable
- 15 2" Canopy

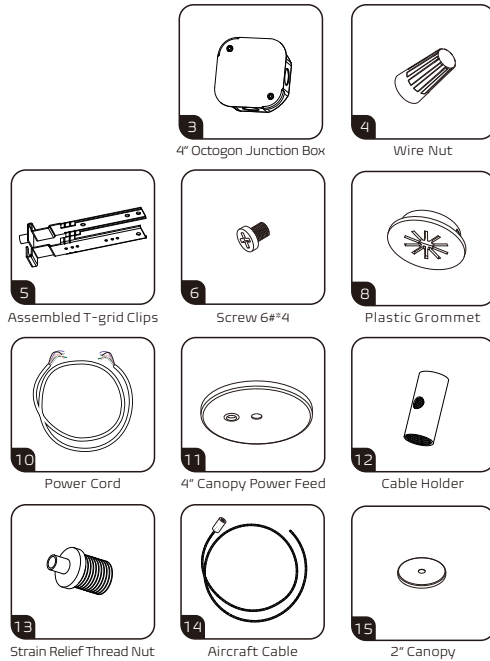

WARNING:

RISK OF FIRE AND ELECTRICAL SHOCK. FIXTURE MUST BE INSTALLED BY A QUALIFIED ELECTRICIAN ONLY IN ACCORDANCE WITH NATIONAL, LOCAL BUILDING AND ELECTRICAL CODES. DISCONNECT POWER AT ELECTRICAL PANEL BEFORE SERVICING.

INDEPENDENT INSTALLATION

VERTICAL LED LUMINAIRE Internal Driver Version

Step1: Hang Luminaire

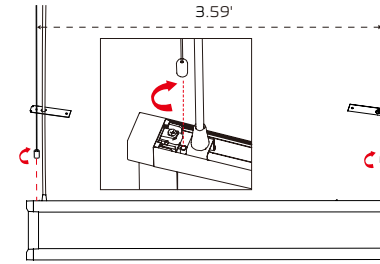

Screw both bottom parts of aircraft cables clockwise and secure them on the top of housing making sure they hang the lights.

Step2: Complete And Remove Bag

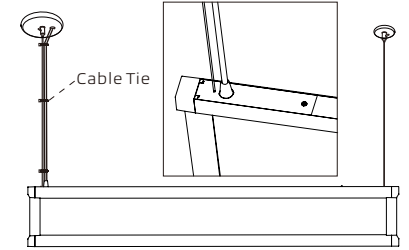

- 2-1: Secure cover plates on both ends of the fixture.
 - 2-2: Zip tight power cord & aircraft suspension cable with the cable tie.
- ▲ Leave the protective bag and protective films on the fixtures until construction and furniture are complete.

MULTIPLE LUMINAIRES CONNECTION

VERTICAL LED LUMINAIRE Internal Driver Version

Pre-installation: Disassemble luminaire's end cap as shown below

Start of run (SoR): Remove the end cap without power code;
Refer to: ①

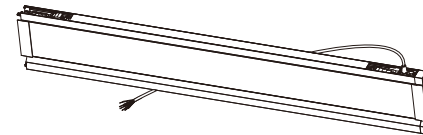

Middle of run (MoR): Remove both end caps
Refer to: ①②③④

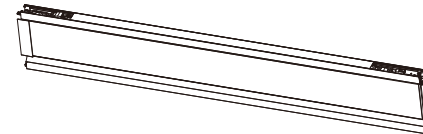

End of run (EoR): Remove the end cap with power code
Refer to: ②③④

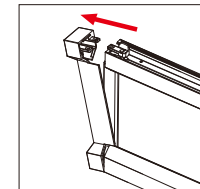

① Take off the end cap (Non-power feed) by screwdriver

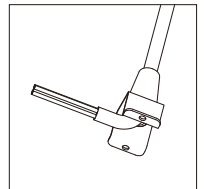

③ Take off the AC cable

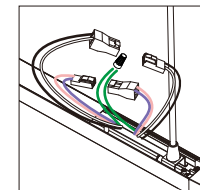

② Pull out the AC cable by removing 2pcs screws.

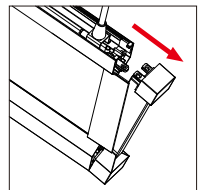

④ Take off the end cap (Power feed) by screwdriver

▶▶ **Step 1: Hang luminaire and wiring - SoR**

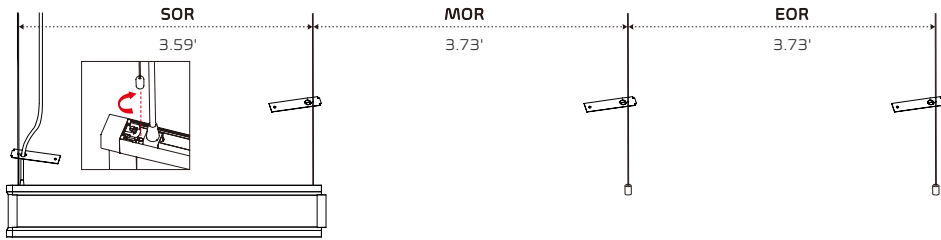

Screw both bottom parts of aircraft cables clockwise and secure them on the top of housing making sure they hang the lights.

▶▶ **Step 2: Hang & Join Fixtures (MoR or EoR)**

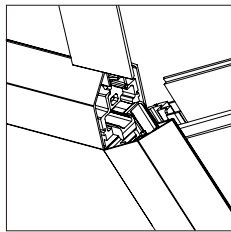
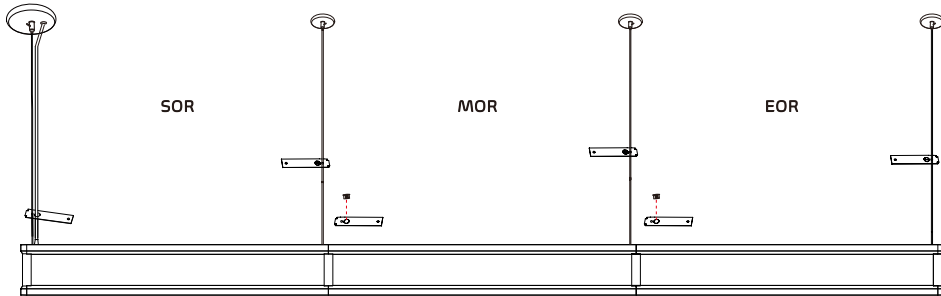

Align position

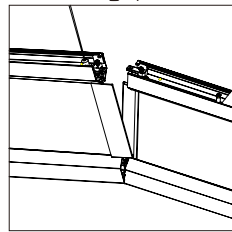

Slide fixtures together

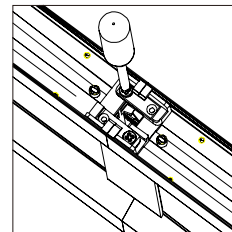

Secure fixtures together via screwdriver

2-1: Joint multiple fixtures together. All continuous runs can be hung one at a time, in order, starting with the SoR, then each fixture sequentially, finishing with the EoR.

2-2: Adjust aircraft suspension cable with leveling tools.

▲ Adjust the height of luminaire. Luminaire can be raised by pulling cable through the gripper and can be lowered by depressing the top cylinder on the gripper which pulls the luminaire down.

Repeat Hang/Join/Seam Finishing steps until Run is completed.

▶▶ **Step 3: Complete And Remove Bags**

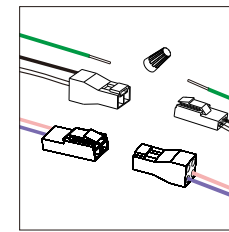
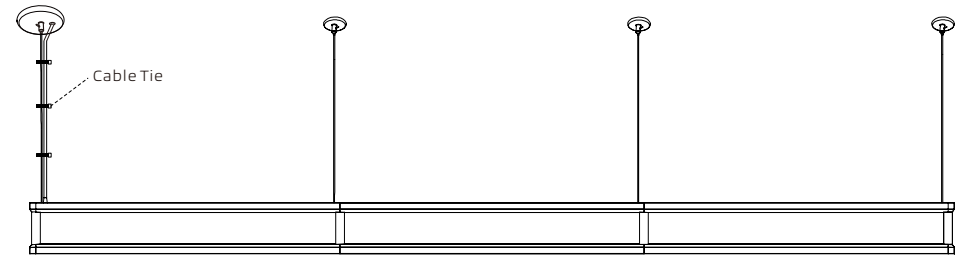

3-1

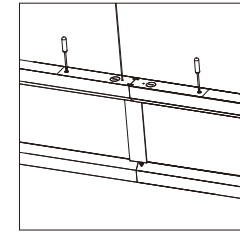

3-2

3-1: Connect internal harnesses

3-2: Secure cover plates on ends of the fixture.

3-3: Zip tight power cord & aircraft suspension cable with the cable tie.

▲ Leave the protective bag and protective films on the fixtures until construction and furniture are complete.

The maximum connection of each input line is less than 40FT(1200CM) in 120AC, less than 80FT (2400CM) in 230AC, less than 100FT(3000CM) in 277AC.