

2.3"/3.8" Width PENDANT LED ARCHITECTURAL LED LUMINAIRE DRY CEILING

⚠ RISK OF FIRE AND ELECTRICAL SHOCK. FIXTURE MUST BE INSTALLED BY A QUALIFIED ELECTRICIAN ONLY IN ACCORDANCE WITH NATIONAL, LOCAL BUILDING AND ELECTRICAL CODES. DISCONNECT POWER AT ELECTRICAL PANEL BEFORE SERVICING.

3.8" Width Linear

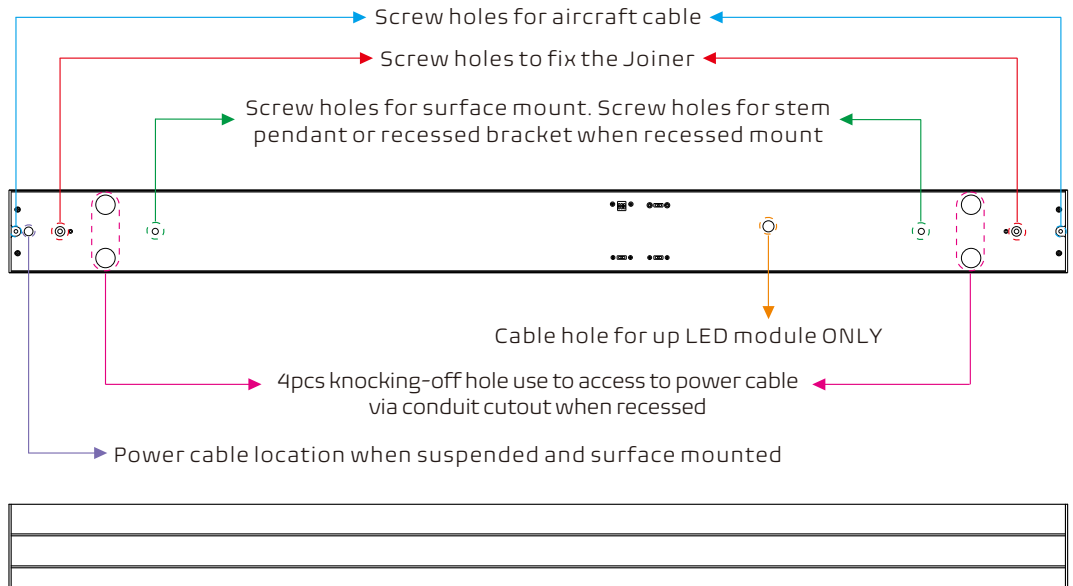

2.3" Width Linear - 1

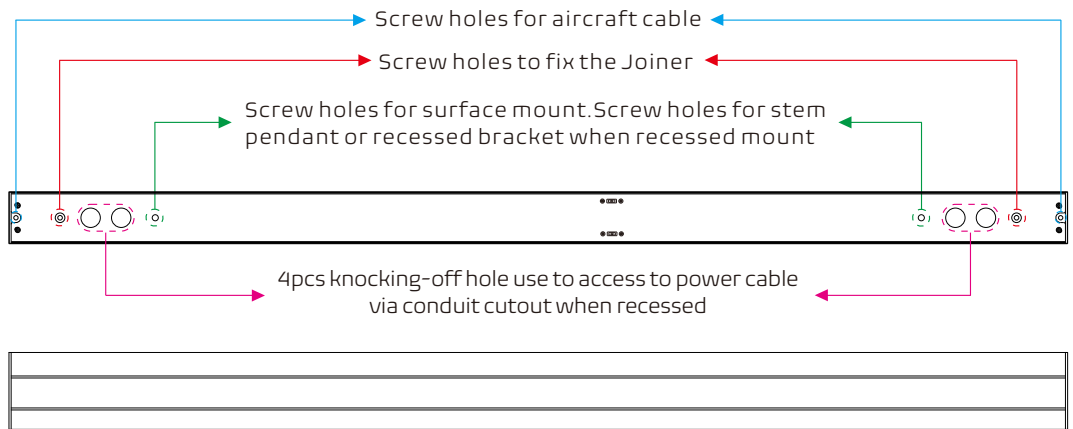

2.3" Width Linear - 2

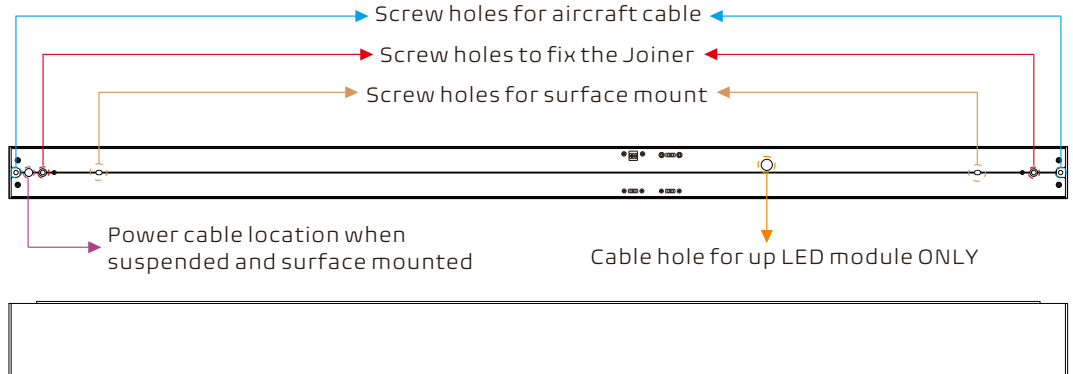

2.3"/3.8" Width PENDANT LED ARCHITECTURAL LED LUMINAIRE DRY CEILING

! RISK OF FIRE AND ELECTRICAL SHOCK. FIXTURE MUST BE INSTALLED BY A QUALIFIED ELECTRICIAN ONLY IN ACCORDANCE WITH NATIONAL, LOCAL BUILDING AND ELECTRICAL CODES. DISCONNECT POWER AT ELECTRICAL PANEL BEFORE SERVICING.

▶ POWER FEED

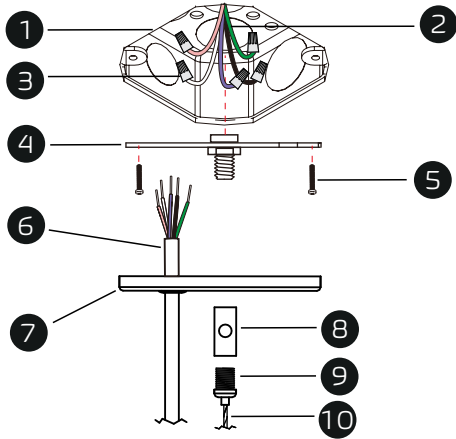

▶ NON POWER SUSPENSION

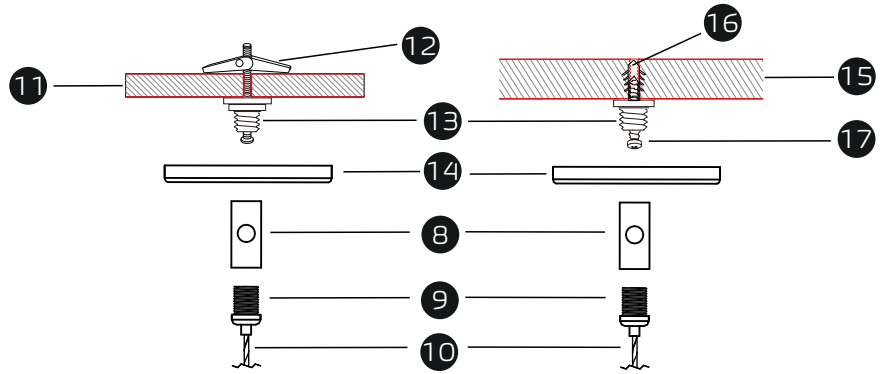

▶ PARTS LIST

- 1 4" Octagon Junction Box (By Others)
- 2 Power Cord (By Others)
- 3 Wire Nut
- 4 Junction Box Crossbar
- 5 Screw PM4*22
- 6 Power Cord
- 7 4" Power Canopy Kit
- 8 Cable Holder
- 9 Strain Relief Thread Nut
- 10 Aircraft Cable
- 11 Drywall Ceiling (By Others)
- 12 Butterfly Drywall Anchor
- 13 Crimp Stud
- 14 2" Canopy
- 15 Solid Ceiling (By Others)
- 16 Anchor
- 17 Screw PA4*30

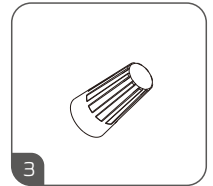

Wire Nut

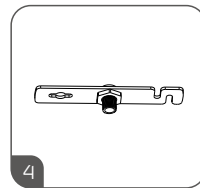

Junction Box Crossbar

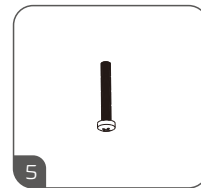

Screw PM4*22

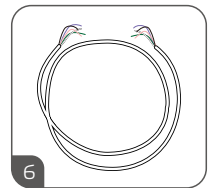

Power Cord

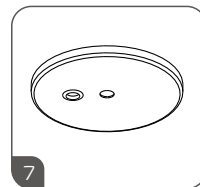

4" Canopy Power Feed

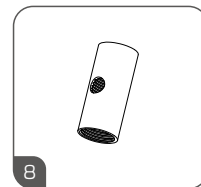

Cable Holder

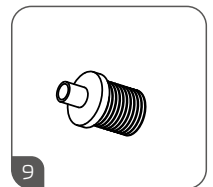

Strain Relief Thread Nut

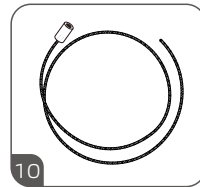

Aircraft Cable

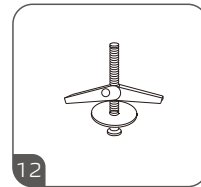

Butterfly Drywall Anchor

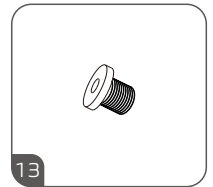

Crimp Stud

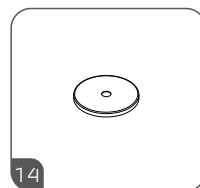

2" Canopy



Anchor

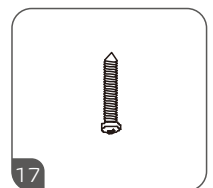

Screw PA4*30

2.3"/3.8" Width PENDANT LED ARCHITECTURAL LED LUMINAIRE DROP CEILING

⚠ RISK OF FIRE AND ELECTRICAL SHOCK. FIXTURE MUST BE INSTALLED BY A QUALIFIED ELECTRICIAN ONLY IN ACCORDANCE WITH NATIONAL, LOCAL BUILDING AND ELECTRICAL CODES. DISCONNECT POWER AT ELECTRICAL PANEL BEFORE SERVICING.

▶ POWER FEED

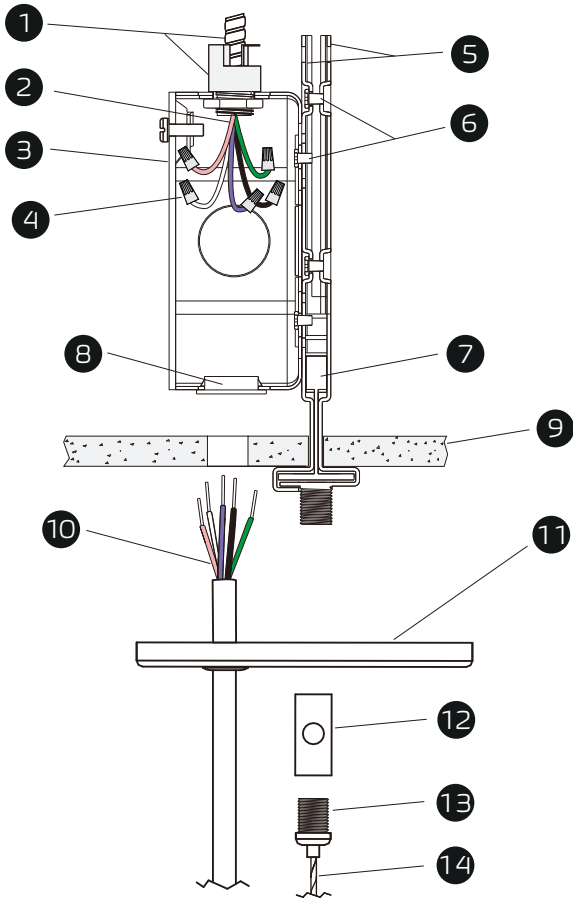

▶ NON POWER SUSPENSION

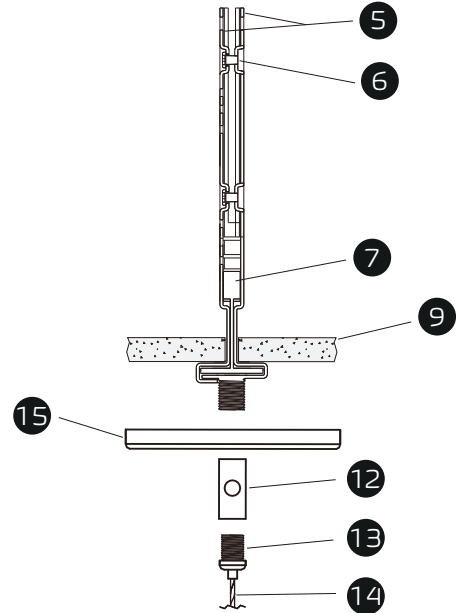

▶ PARTS LIST

- 1 Armored Cable & Connector (By Others)
- 2 Power Cord (By Others)
- 3 4" Octagon Junction Box
- 4 Wire Nut
- 5 Assembled T-grid Clips
- 6 Screw 6#*4
- 7 T-grid (By Others)
- 8 Plastic Grommet
- 9 Ceiling Tile (By Others)
- 10 Power Cord
- 11 4" Canopy Power Feed
- 12 Cable Holder
- 13 Strain Relief Thread Nut
- 14 Aircraft Cable
- 15 2" Canopy

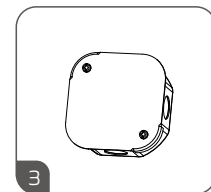

3 4" Octagon Junction Box

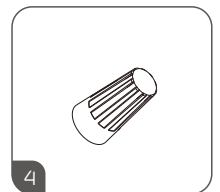

4 Wire Nut

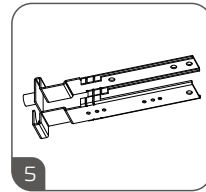

5 Assembled T-grid Clips

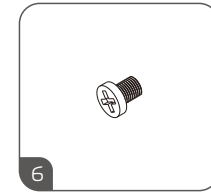

6 Screw 6#*4

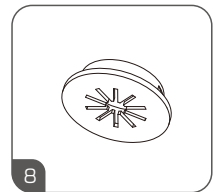

8 Plastic Grommet

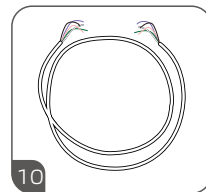

10 Power Cord

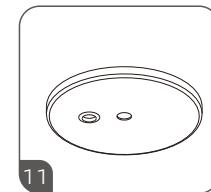

11 4" Canopy Power Feed

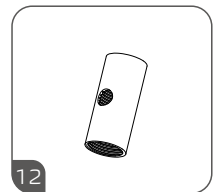

12 Cable Holder

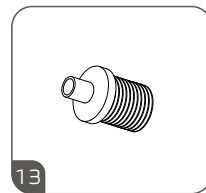

13 Strain Relief Thread Nut

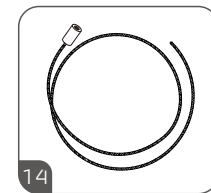

14 Aircraft Cable

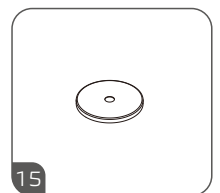

15 2" Canopy

2.3"/3.8" Width PENDANT LED ARCHITECTURAL LED LUMINAIRE INDEPENDENT INSTALLATION

⚠ RISK OF FIRE AND ELECTRICAL SHOCK. FIXTURE MUST BE INSTALLED BY A QUALIFIED ELECTRICIAN ONLY IN ACCORDANCE WITH NATIONAL, LOCAL BUILDING AND ELECTRICAL CODES. DISCONNECT POWER AT ELECTRICAL PANEL BEFORE SERVICING.

IMPORTANT

1. Read all instructions.
2. Install in accordance with national and local electrical code regulations.
3. This product is intended to be installed and serviced by a qualified, licensed electrician.
4. Do not install in wet locations. For dry and damp use only.
5. Turn off electrical power before installing or servicing fixture in any way.
6. To reduce the risk of fire and overheating, make sure all connections are tight.
7. Under no circumstances can the lighting fixture be covered with heat insulation gasket or similar materials.
8. The maximum connection of each input line is 40FT(1200CM) in 120AC, 80FT (2400CM) in 230AC, 100FT(3000CM) in 277AC.

SHOCK HAZARD

⚡ May result in serious injury or death. Turn power OFF at circuit breaker prior to installation or servicing.

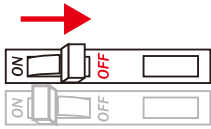

WIRING

CORD / SUPPLY WIRING		LUMINAIRE	
LINE	●	LINE- BLACK	●
GREEN	●	GROUND-GREEN	●
NEUTRAL	●	NEUTRAL- WHITE	●
DIM (+) VIOLET	●	VIOLET	●
DIM (-) PINK	●	PINK	●

⚠ Please isolate two dimming wires by P2 terminal individually if no need dimming; **MUST connect wires with corresponding colors as shown.**

PRE-INSTALLATION

Assemble Luminaire

1. Insert the cord holder into the power code location as shown.
2. Thread the power code into the cord holder as shown, and secure the LED modular to housing with safety cable.
3. Wiring Must connect connectors with corresponding colors as shown.
4. Fix the power code with holder nut, insert the LED modular into housing, then install the end cap into housing with screws.

INDEPENDENT INSTALLATION

1 Hang Luminaire

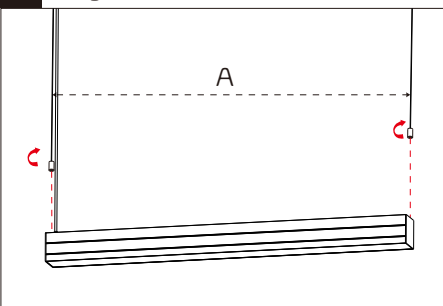

Screw both bottom parts of aircraft cables clockwise and secure then on the top of housing making sure they hang the lights.

Note: Adjust the height of luminaire. Luminaire can be raised by pulling cable through the gripper and can be lowered by depressing the top cylinder on the gripper which pulls the luminaire down.

2 Complete

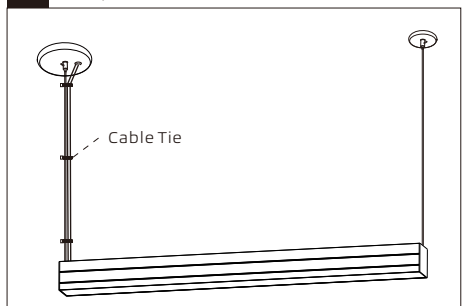

Use the cable tie to keep the electric wire going up along with the wire rope.

Nominal Length	2.3" or 3.8" Width Linear (Diffuser, Regress, Wall Wash)	2.3" Width Linear (Reflector, Louver)
	"A" Suspension Points Distance (Feet)	"A" Suspension Points Distance (Feet)
2 ft.	1.92'	1.93'
3 ft.	2.92'	2.92'
4 ft.	3.92'	3.90'
8 ft.	7.88'	7.84'

2.3"/3.8" Width PENDANT LED ARCHITECTURAL LED LUMINAIRE MULTIPLE LUMINAIRES CONNECTION

⚠ RISK OF FIRE AND ELECTRICAL SHOCK. FIXTURE MUST BE INSTALLED BY A QUALIFIED ELECTRICIAN ONLY IN ACCORDANCE WITH NATIONAL, LOCAL BUILDING AND ELECTRICAL CODES. DISCONNECT POWER AT ELECTRICAL PANEL BEFORE SERVICING.

JOINER OPTIONS

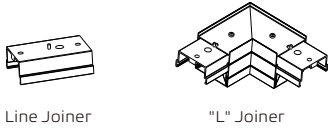

Line Joiner

"L" Joiner

ACCESSORY



Silicone Seal

Note: Silicone seal is used to seal seams that may appear at both ends of luminaires when multiple connections.

BEFORE CONNECTING

Disassemble Luminaires

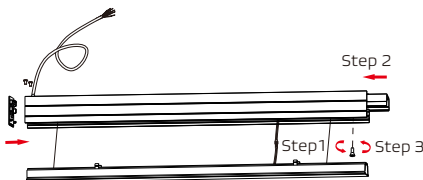

Start of run (SoR):

Beginning at one end, install power cord, first end cap and line joiner, secure the led modular to housing with safety cable.

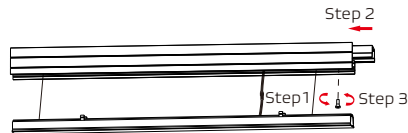

Middle of run (MoR):

Install line joiner, secure the led modular to housing with safety cable.



End of run (EoR):

Install the end cap to the end of fixture, secure the led modular to housing with safety cable.

LINE CONNECTION

1 Install aircraft cable

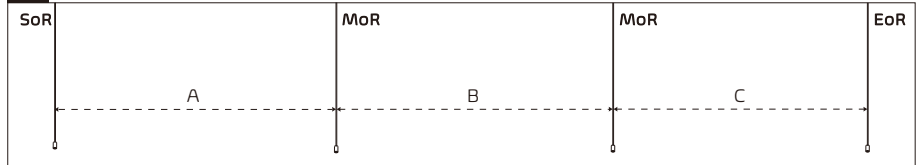

Nominal Length	2.3" or 3.8" Width Linear (Diffuser, Regress, Wall Wash)			2.3" Width Linear (Reflector, Louver)		
	"A" Distance of SoR to MoR Feet	"B" Distance of MoR to MoR Feet	"C" Distance of MoR to EoR Feet	"A" Distance of SoR to MoR Feet	"B" Distance of MoR to MoR Feet	"C" Distance of MoR to EoR Feet
2 ft.	1.94'	1.96'	1.94'	1.95'	1.97'	1.95'
3 ft.	2.94'	2.96'	2.94'	2.94'	2.95'	2.94'
4 ft.	3.94'	3.96'	3.94'	3.92'	3.94'	3.92'
8 ft.	7.90'	7.92'	7.90'	7.86'	7.87'	7.86'

2 Hang luminaire and wiring - SoR

▲ Adjust the height of luminaire.
Luminaire can be raised by pulling cable through the gripper and can be lowered by depressing the top cylinder on the gripper which pulls the luminaire down.

2-1: Screw both bottom parts of aircraft cables clockwise and secure them on the top of housing making sure they hang the lights.
2-2: Connect AC power.

3 Repeat Hang and join steps - MoR to EoR

Wiring: Must connect connectors with corresponding colors as shown.

3-1: Zip tight power cord & aircraft suspension cable with the cable tie.
3-2: Connect the quick connectors properly.
3-3: Insert all the LED Modules into the housing from SoR to EoR in turn.

4 Complete

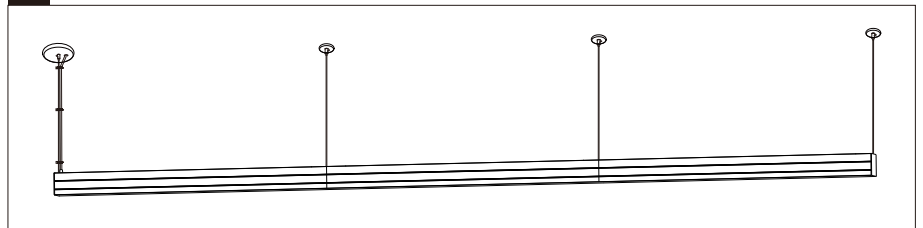

Optional 42' Continuous Rolling Lens

Diffuser (Optional Accessories)
Optional continuous rolling lens which can reach seamless continue runs up to 42' is available.

2.3"/3.8" Width PENDANT LED ARCHITECTURAL LED LUMINAIRE MULTIPLE LUMINAIRES CONNECTION

! RISK OF FIRE AND ELECTRICAL SHOCK. FIXTURE MUST BE INSTALLED BY A QUALIFIED ELECTRICIAN ONLY IN ACCORDANCE WITH NATIONAL, LOCAL BUILDING AND ELECTRICAL CODES. DISCONNECT POWER AT ELECTRICAL PANEL BEFORE SERVICING.

L SHAPE CONNECTION

- ▲ For "T", "+", "Y" shape or other geometric shapes, all subject to the "L" shape installation.
- ▲ It needs 2 inputs if using joiner "T", "+" and "Y".

BEFORE CONNECTING

Disassemble Luminaires

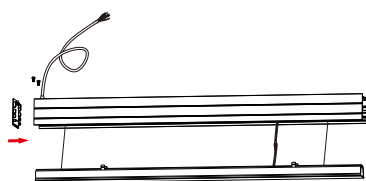

Start of run (SoR):
Install power cord and first end cap, secure the led modular to housing with safety cable.

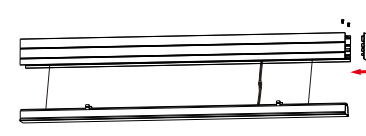

End of run (EoR):
Install the end cap to the end of fixture, secure the led modular to housing with safety cable.

1 Install joiners

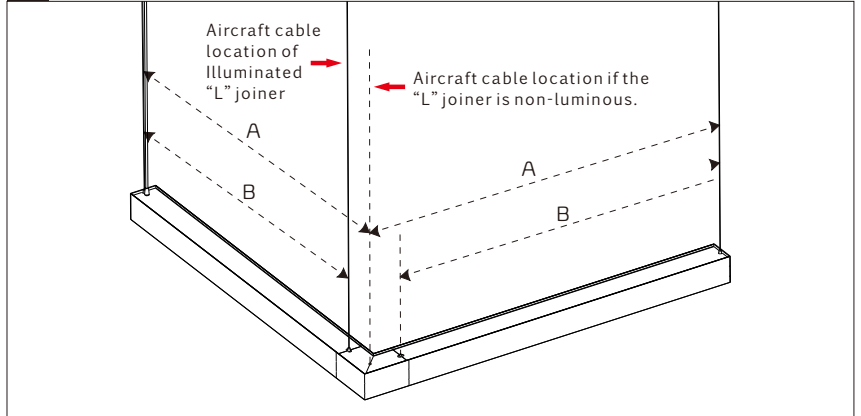

Nominal Length	2.3" Width Linear (Diffuser, Regress, Wall Wash)		2.3" Width Linear (Reflector, Louver)		3.8" Width Linear (Diffuser, Regress, Wall Wash)	
	"A" Illuminated "L" joiner Feet	"B" Illuminated "L" joiner Feet	"A" Non-luminous "L" joiner Feet	"A" Non-luminous "L" joiner Feet	"A" Illuminated "L" joiner Feet	"B" Illuminated "L" joiner Feet
2 ft.	2.27'	1.94'	2.04'	2.05'	2.33'	1.94'
3 ft.	3.27'	2.94'	3.04'	3.03'	3.33'	2.94'
4 ft.	4.27'	3.94'	4.04'	4.02'	4.33'	3.94'
8 ft.	8.23'	7.90'	8.00'	7.96'	8.29'	7.90'

2 Insert the "L" joiner to the first housing

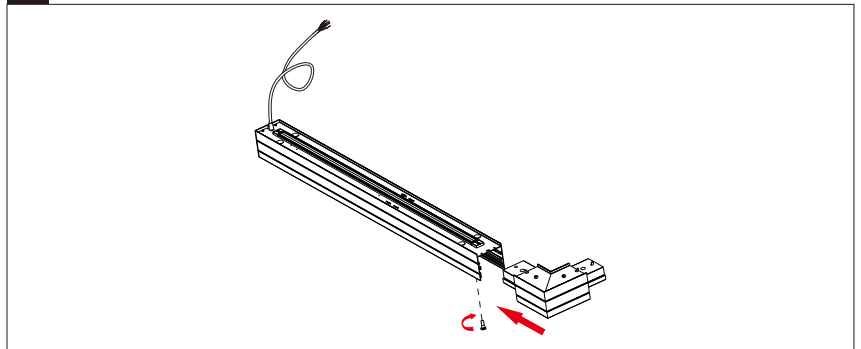

3

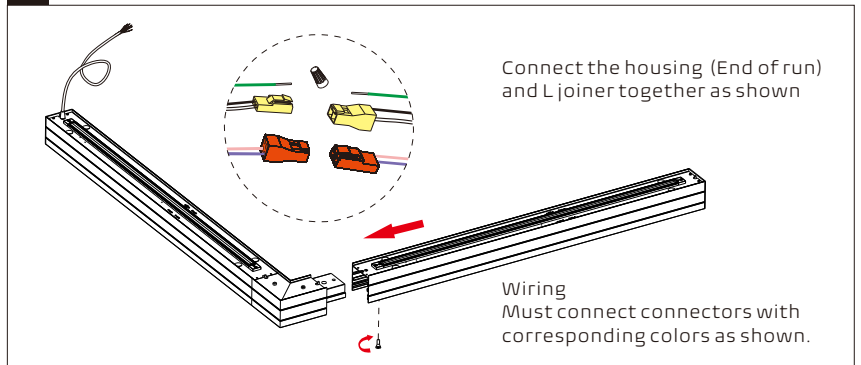

2.3"/3.8" Width PENDANT LED ARCHITECTURAL LED LUMINAIRE MULTIPLE LUMINAIRES CONNECTION

⚠ RISK OF FIRE AND ELECTRICAL SHOCK. FIXTURE MUST BE INSTALLED BY A QUALIFIED ELECTRICIAN ONLY IN ACCORDANCE WITH NATIONAL, LOCAL BUILDING AND ELECTRICAL CODES. DISCONNECT POWER AT ELECTRICAL PANEL BEFORE SERVICING.

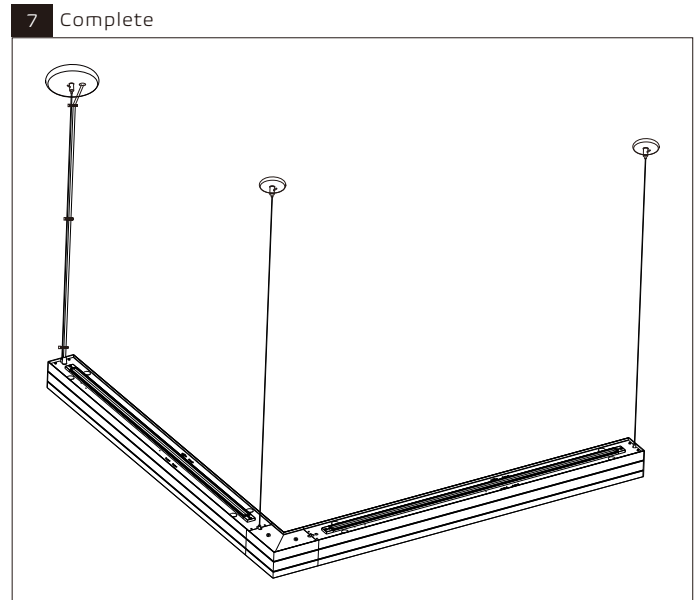
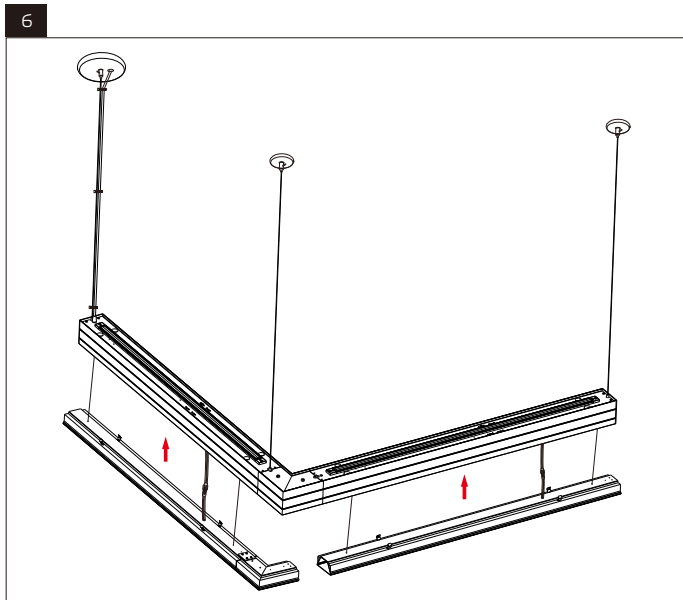
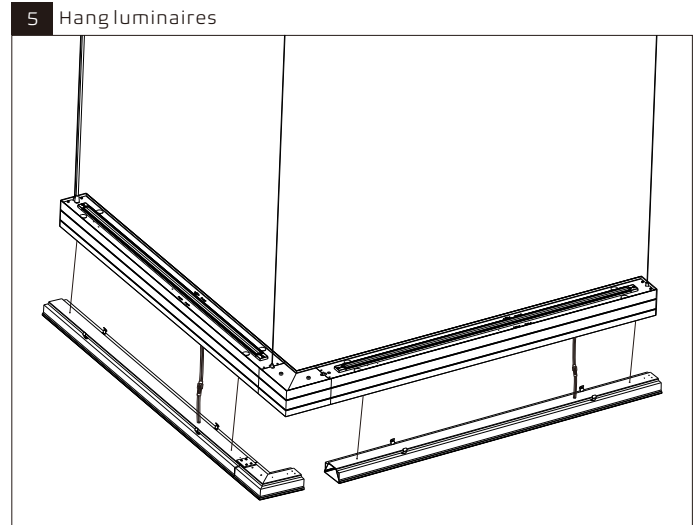
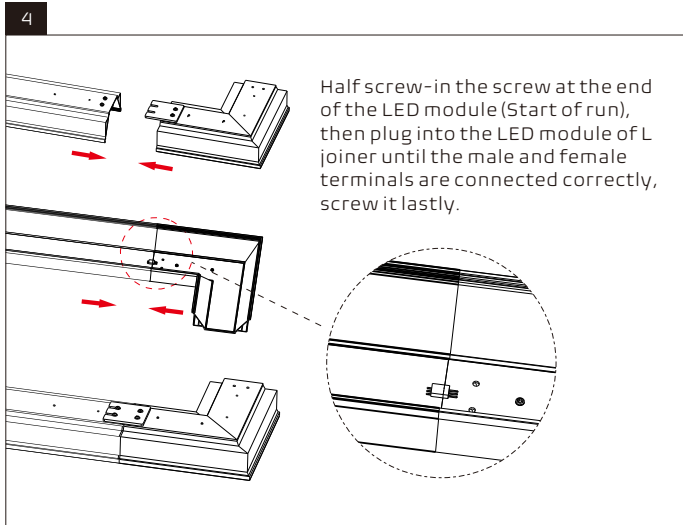

5-1: Zip tight power cord & aircraft suspension cable with the cable tie.
5-2: Insert all the LED Modules into the housing from SoR to EoR in turn.

Optional 42' Continuous Roll-out Lens

