



ZETA

1.8 INCH WIDTH LINEAR LIGHT



DEFINE AND DIFFERENTIATE

OKT Lighting is a known brand in North America widely recognized for its innovative LED lighting solutions with reliability, visual appeal, and high performance. Now, we have made it even easier for you to choose the right lighting solution without investing considerable time or compromising your expectations. It was named after the Greek letter Zeta, the shape of the letter Z resembles lighting.

ZETA 1.8inch width linear solutions by OKT Lighting deliver a seamless synthesis of aesthetics, performance and affordable pricing. OKT engineers know how to help achieve the look and ambience customers desire, while minimizing product cost, energy and maintenance costs. This means that you can confidently identify and implement the lighting solution to best suit your needs.

Clean lines Sleek styling

Our Linea small-scale units represent the most popular in linear style. The rectilinear 1.8" delivers a sleek, architecturally pure linear solution for commercial and retail direct and indirect ambient lighting. This Zeta 1.8inch product provides you with a superior esthetics, quality performance and unparalleled versatility that complement most lighting application.

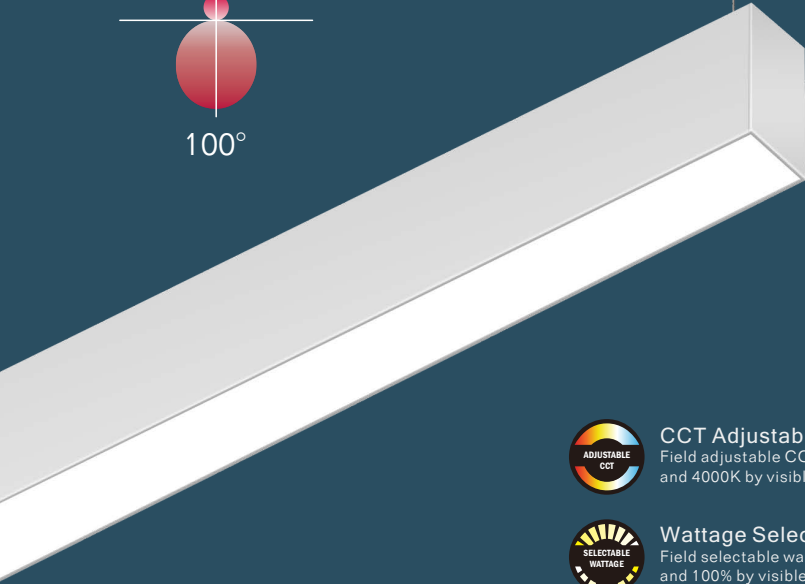
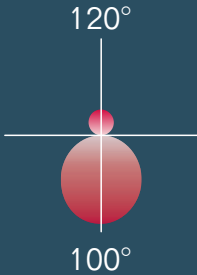

CCT Adjustable

Field adjustable CCT from 3000K, 3500K and 4000K by visible DIP switch.



Wattage Selectable

Field selectable wattage from 50%, 75% and 100% by visible DIP switch.



Multiple Distribution

You can choose 25% up/75% down, 100% down by visible DIP switch.



Seamless Continuous Runs

Create clean, seamless runs that are up to 40' in 120V, 100' in 277V, 120' in 347V.



Lighting Design Flexibility

Unleash lighting design flexibility with different patterns by Line, L, X, T, Y, V joiners.

 The upgraded performances compared to the previous version.

Puts flexibility at your fingertips

CONFIGURE 100 OPTIONS WITH ONLY 3 SKUS

Make your project
more flexible, simple,
and less costly.

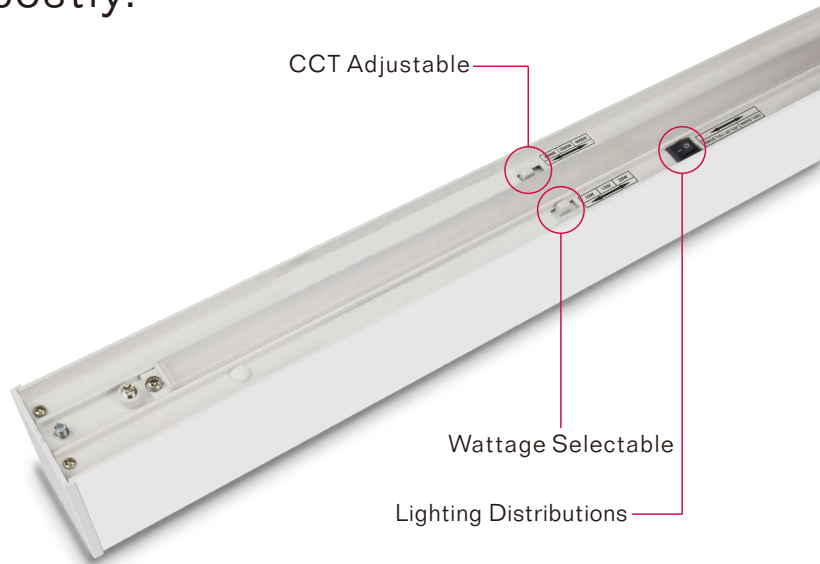

Most of our customers have been struggling with inventory control, now you can fulfill more orders with fewer SKUs!

Precisely Controlled Light

DISTRIBUTIONS OPTIONS

Providing flexibility
in how a space is
illuminated!

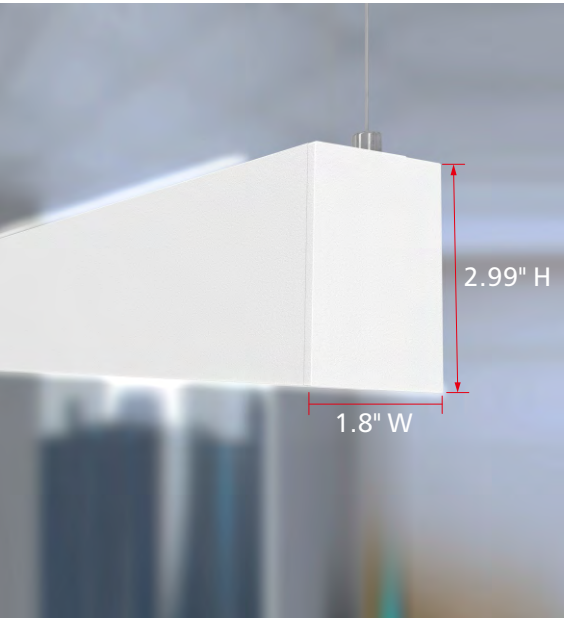
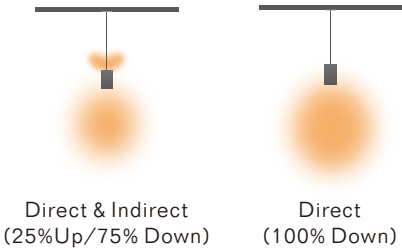

OKT understands the lighting professional's need for versatility, so we make sure your toolbox is equipped.

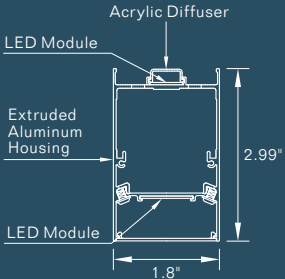

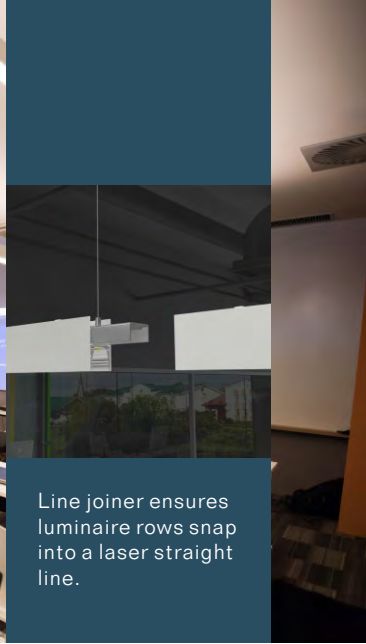

Line Joiner ensures luminaire rows snap into a laser straight line.

SEAMLESS LINEAR

It's a highly engineered luminaire, joining design allows for simple and intuitive assembly in the field. Its Line Joiner ensures that luminaire rows snap into a laser straight line for exceptional design flexibility.

One power can feed multiple lamps to minimize installation time and save labor cost. Runs of luminaires that are up to 120ft in length are designated. This means that the run is comprised of a combination 2ft, 4ft and/or 8ft sections to be assembled on site using our joining system.

- 40' in 120V
- 100' in 277V
- 120' in 347V*



40' Rolling Lens

To facilitate and accelerate installation, 40' rolling lens features field-cuttable diffuser for a precise finish.

THE CREATIVE DESIGN

ZETA 1.8" width linear lends itself to the creation of streamlined shapes and patterns that support a room's purpose and multiple functions. It adds fun factor into each room. Its clean look and extensive possibilities let you suggest rhythm, communicate meaning and create neighborhoods of light.

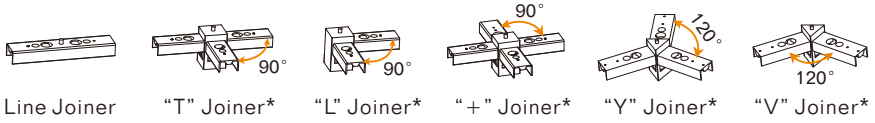



VERSATILE MOUNTINGS

OKT brings a family approach that lets you coordinate these ZETA 1.8" linear luminaires as required with style-matched pendant, surface, and wall products.



Pendant:
Dry ceiling and T-grid ceiling compatible.



Surface
Quick install -DON'T need to remove up led module.



Wall Mount

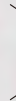

The same luminaire,
more flexible to keep stock.

Optional Function

EMERGENCY OPTION

Up to 90 minutes
minimum in event
of power failure!



Standard



Optional external 18w or 25w
UL& CEC Listed high voltage
LED emergency driver designed
with high-quality Lithium
battery can be provided and do
it wire quickly in field.

Optional Function OCCUPANCY SENSOR

Using technology to
make spaces smarter,
more energy-saving!



Sensor Coverage

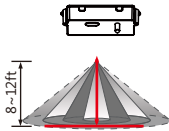

Height of installation 8-12ft

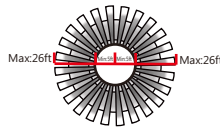

(Height of installation 8ft)
Detection Range

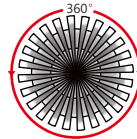

























Detection Angel



Provide a factory-installed integrated sensor kit for multi-level control based on motion and/or daylight contribution with daylight harvest microwave sensor from SHARKWARD.

ZETA 1.8" LINEAR OPTIONS

Mounting Options	 Pendant QS	 Surface QS	 Wall Mount QS			
Finishes	 White QS	 Black QS	 Custom Color			
Wattage Selectable 	 2FT 20W/15W/10W QS	 4FT 40W/30W/20W QS	 8FT 80W/60W/40W QS			
Lighting Distributions 	 Direct (100% Down) QS	 Direct & Indirect (25% Up & 75% Down) QS				
0-10V Dimming	Dim to 10% (Standard) QS	Dim to 1%				
Optics	 Diffuser QS					
CCT Adjustable 	 3000K QS	 3500K QS	 4000K QS			
CRI	 80+ CRI (Standard) QS					
Joiners	 Line Joiner QS	 "T" Joiner*	 "L" Joiner*	 "X" Joiner*	 "Y" Joiner*	 "V" Joiner*
Optional Functions	Motion sensor or emergency LED driver for lighting up to 90 minutes in event of power failure is available. QS					

• 110~277V Standard, 110~347V Available

• Damp Rated

• 50,000 hrs/5 years limited



QS = QuickShip

* means additional cost and/or lead time on customized fixtures may apply. Some fixtures require an MOQ. Please contact your sales rep for more information.



Manufacturing HQ
Room G 10/F, Kechuang Building,
Quanzhi Science and Technology
Innovation Park, Houting, Shajing,
Bao'an, Shenzhen, China.
+86-755-61157553

Customer Service Center
10641 S Sam Houston Pkwy West,
Suite 100, Houston, TX 77071
+1-832-493-4790

sales@oktlighting.com
www.oktlighting.com

@OKT Lighting. All right reserved.
Product design and development is an
ongoing process by OKT Lighting. We
reserve the right to change
specifications. Contact OKT for the
latest product information or visit
website for more.