

META Surface-Wall Mount

Spec-grade | Vertical Architectural LED Linear Lighting



The Meta Surface is available in a surface reverted design, with a sleek low-profile sensibility optimal for architectural lighting applications, ideal for corridors, stairwells, and more. Meta Surface’s eye-catching, sloping silhouette profile features an elegant finishing touch, with simple screws or threaded studs which pass through the housing to mount the luminaire in place.

With wattage selectable and CCT adjustable function, Meta Surface also has the flexibility to illuminate many types of spaces, packing a powerful punch of up to 1600 lumen per foot with 90+CRI.

Feature

- 3 lengths & sloping silhouette
- Transparent optics
- Wattage selectable, up to 1600 lm/ft
- True color, 90+CRI
- CCT adjustable from 3000K, 3500K and 4000K

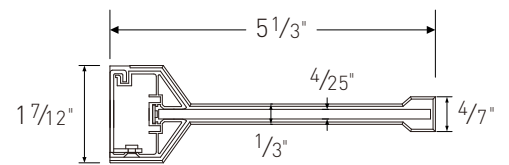
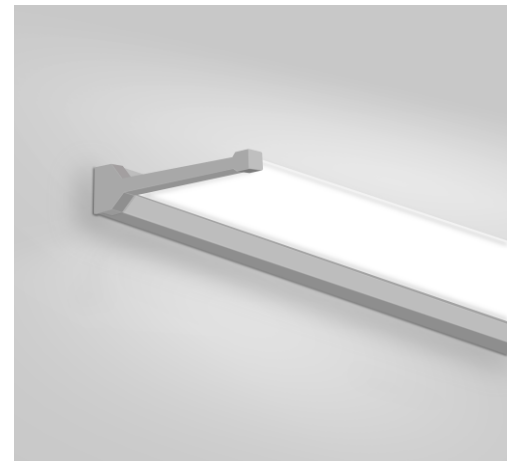



ADJUSTABLE CCT
 3000K
 3500K
 4000K

SELECTABLE WATTAGE
 High
 Medium
 Low



*DesignLights Consortium Qualified and classified for DLC standard / premium, refer to www.designlights.org for details

PERFORMANCE

Model#	Length	Lumen Package			
		Wattage	3000K	3500K(DLC Qualification)	4000K(DLC Qualification)
LV4-ITW2F	2'	20W	1150lm/ft, 115lm/w	1250lm/ft, 125lm/w	1200lm/ft, 120lm/w
LV4-ITW3F	3'	20W/30W/40W Selectable	750~1500lm/ft, 115lm/w	800~1650lm/ft, 125lm/w	800~1600lm/ft, 120lm/w
LV4-ITW4F	4'	20W/30W/40W Selectable	550~1150lm/ft, 115lm/w	600~1250lm/ft, 125lm/w	600~1200lm/ft, 120lm/w

*All efficacy is ±5% base on different CCT. Check the IES file to gain the accurate data.

META Surface-Wall Mount

Spec-grade | Vertical Architectural LED Linear Lighting





PRODUCT ORDERING GUIDE

Example: LV4-ITW2F (Wall)

LV4	I	TW		(Wall)
Product Series	Driver	CCT	Length & Wattage	Just to remark the mounting. Don't show in product label.
LV4 Meta Surface Linear	I Internal Driver	TW CCT Adjustable 3000K/3500K/4000K	2F 2 Feet,20W QuickShip	
			3F 3 Feet,20W/30W/40W Selectable QuickShip	
			4F 4 Feet,20W/30W/40W Selectable QuickShip	

OPTIONAL ACCESSORY

Mounting	Optional Function
SMK QuickShip Surface Mounting Kits 	EME QuickShip Emergency Function (Only external 8w or 25w LED emergency driver with standard indicator available and need field-installed.) 

STRUCTURE

► Finish

Extruded aluminum housing with powder coat white finish or custom.

► Optics

Ultra-thin semi-transparent vertical optics, enveloped in a signature sloping silhouette where the frame meets the optics.

► Electrical

Mini Internal LED Driver It is powered by Class 2 high efficiency LED driver, with a standard 1-10V dimming which continuous dims to 10% that works with many types of controls. Tested Dimmers: Lutron® Diva-Dvtv, Leviton® IP-710-DL.

THD <20%

Power Factor >0.9

Input Voltage Standard electronic drivers are UL recognized and available for 110-277V or 110-347V AC* input voltage.

► LED System

CRI Minimum 90 color rendering index.

CCT CCT adjustable from 3000K, 3500K and 4000K with a great color consistency.

LED Minimum 50,000h with 87.8% of lumen maintenance in 25°C ambient temperature, in compliance with IES LM-80 testing measurements.

Environment Damp rated for ambient operating temperature of -20°C to +40°C (-4° to +104°F).

DIMENSIONS

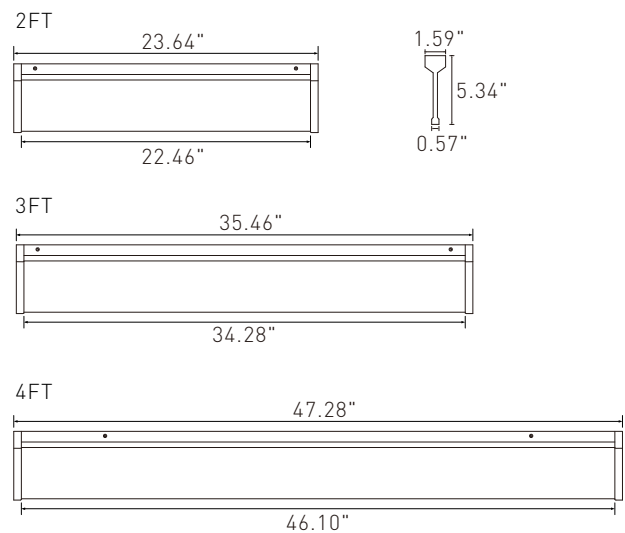

META Surface-Wall Mount

Spec-grade | Vertical Architectural LED Linear Lighting



DISTRIBUTION DIAGRAM

2' / 3500K

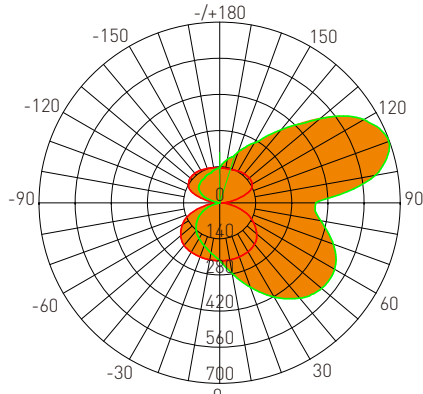

AVERAGE BEAM ANGLE(50%): 351.1°

Test Number: LV4-ITW2F
 Lumens: 2512.85 Lm
 Watts: 20 W
 LPW: 128.57 Lm/W
 CCT: 3500K

UNIT: cd
 — C0/180,360.0°
 — C90/270,342.2°

Zonal Flux Diagram

τ	C0	C45	C90	C135	C180
10	224.9	260.4	278.2	260.2	224.7
20	223.0	303.3	347.6	303.8	223.2
30	219.4	341.2	421.9	345.3	221.5
40	209.9	369.1	482.6	378.7	215.3
50	187.3	375.2	516.3	391.0	197.7
60	151.2	351.3	514.3	373.0	166.9
70	103.0	299.8	469.0	324.0	118.7
80	43.46	236.7	398.2	249.3	50.06
90	7.271	207.4	372.8	202.8	3.729
100	53.79	302.1	611.9	293.1	46.49
110	116.7	370.3	696.7	366.9	108.8
120	145.2	364.3	646.1	364.2	140.2
130	150.2	323.4	507.3	327.7	149.4
140	147.6	267.5	370.0	272.0	150.2
150	142.7	216.6	268.7	219.6	146.6
160	137.6	181.8	210.5	186.2	141.7
170	136.0	157.7	170.9	157.2	138.7
180	136.0	136.0	136.0	136.0	136.0
DEG	LUMINOUS INTENSITY:cd				

Zonal Lumens

τ	φ total
0-10	21.83
10-20	89.49
20-30	206.0
30-40	370.8
40-50	574.7
50-60	796.0
60-70	1005
70-80	1171
80-90	1289
90-100	1432
100-110	1649
110-120	1892
120-130	2015
130-140	2269
140-150	2383
150-160	2457
160-170	2449
170-180	2513
	UNIT: lm

Luminance cd/(m2)

G(DEG)	C0/180	C90/270
85	2408	42710
80	2502	22934
75	2773	16727
70	3012	13714
65	3007	11767
60	3023	10285
55	2970	9059
50	2913	8303
45	2849	7119

3' / 3500K

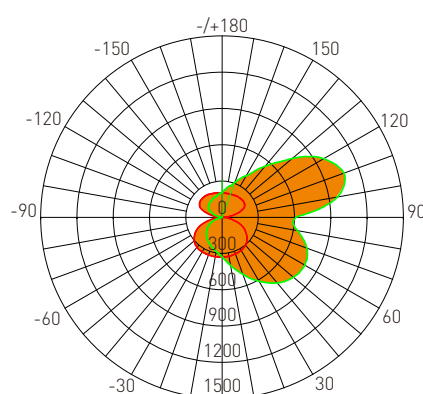

AVERAGE BEAM ANGLE(50%): 530.3°

Test Number: LV4-ITW3F
 Lumens: 3802.9 Lm
 Watts: 30 W
 LPW: 129.45 Lm/W
 CCT: 3500K

UNIT: cd
 — C0/180,360.0°
 — C90/270,340.6°

Zonal Flux Diagram

τ	C0	C45	C90	C135	C180
10	327.0	376.9	403.0	380.7	331.1
20	322.4	434.5	501.6	445.4	331.2
30	315.6	487.4	610.2	510.0	331.4
40	301.1	528.5	709.0	567.0	324.6
50	270.2	543.4	769.8	594.9	301.4
60	221.4	516.6	789.7	578.0	257.9
70	153.7	452.4	745.3	516.0	185.8
80	65.59	367.1	633.0	419.2	79.22
90	10.93	327.3	611.0	362.3	6.695
100	80.27	458.6	968.4	497.2	74.23
110	173.8	552.4	1072	592.1	171.0
120	215.3	535.8	972.4	568.2	217.3
130	221.6	476.1	757.5	499.7	228.5
140	217.8	391.5	553.5	410.8	227.4
150	211.5	317.5	398.3	327.9	220.8
160	204.9	267.5	309.8	275.7	212.4
170	202.7	231.9	250.9	232.2	207.1
180	202.5	202.5	202.5	202.5	202.5
DEG	LUMINOUS INTENSITY:cd				

Zonal Lumens

τ	φ total
0-10	31.83
10-20	130.3
20-30	299.7
30-40	540.2
40-50	839.9
50-60	1170
60-70	1491
70-80	1752
80-90	1943
90-100	2176
100-110	2512
110-120	2879
120-130	3197
130-140	3440
140-150	3610
150-160	3721
160-170	3783
170-180	3803
	UNIT: lm

Luminance cd/(m2)

G(DEG)	C0/180	C90/270
85	3653	67819
80	3777	36453
75	4161	26822
70	4493	21791
65	4551	18383
60	4429	15793
55	4315	13717
50	4203	11976
45	4090	10537

META Surface-Wall Mount

Spec-grade | Vertical Architectural LED Linear Lighting



DISTRIBUTION DIAGRAM

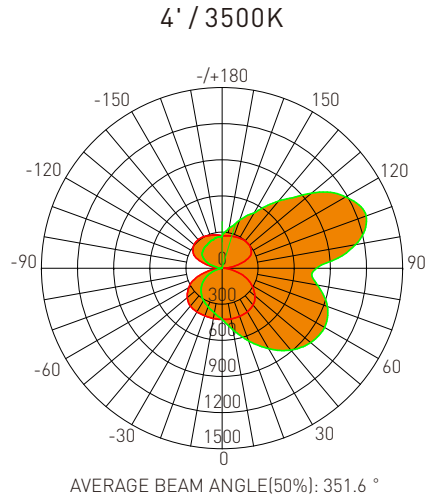

Test Number: LV4-ITW3F
 Lumens: 4876.5 Lm
 Watts: 40 W
 LPW: 125.42 Lm/W
 CCT: 3500K

UNIT: cd
 — C0/180,360.0°
 — C90/270,343.2 °

Zonal Flux Diagram

τ	C0	C45	C90	C135	C180
10	428.0	488.8	519.1	489.2	424.6
20	425.5	563.5	640.8	566.9	421.0
30	418.3	636.4	770.2	646.8	419.7
40	399.2	687.5	887.5	708.3	410.5
50	355.2	705.3	961.5	738.4	378.7
60	286.0	663.9	983.1	711.6	320.2
70	195.1	576.6	929.4	637.5	228.5
80	83.96	465.8	803.3	522.3	97.71
90	16.76	414.9	786.3	452.3	7.746
100	104.3	571.3	1124	586.8	92.95
110	223.3	689.7	1273	702.4	214.3
120	281.5	686.0	1185	711.2	280.1
130	297.2	622.0	973.0	648.9	305.1
140	297.6	528.1	729.5	553.2	310.6
150	291.0	433.8	531.8	444.1	303.7
160	281.6	367.9	426.6	380.2	291.7
170	275.5	315.4	340.1	315.9	281.5
180	269.6	269.6	269.6	269.6	269.6
DEG	LUMINOUS INTENSITY:cd				

Zonal Lumens

τ	φ total
0-10	41.35
10-20	169.2
20-30	389.0
30-40	699.7
40-50	1084
50-60	1504
60-70	1906
70-80	2233
80-90	2476
90-100	2762
100-110	3174
110-120	3636
120-130	4052
130-140	4379
140-150	4611
150-160	4764
160-170	4850
170-180	4877
	UNIT: lm

Luminance cd/(m2)

G(DEG)	C0/180	C90/270
85	4834	85979
80	4835	46260
75	5283	33747
70	5703	27174
65	5816	22872
60	5720	19661
55	5627	17062
50	5526	14958
45	5412	13157