

1.3" PENDANT LED ARCHITECTURAL LED LUMINAIRE

! RISK OF FIRE AND ELECTRICAL SHOCK. FIXTURE MUST BE INSTALLED BY A QUALIFIED ELECTRICIAN ONLY IN ACCORDANCE WITH NATIONAL, LOCAL BUILDING AND ELECTRICAL CODES. DISCONNECT POWER AT ELECTRICAL PANEL BEFORE SERVICING.

The product styles you received

First style: finished product with power cord

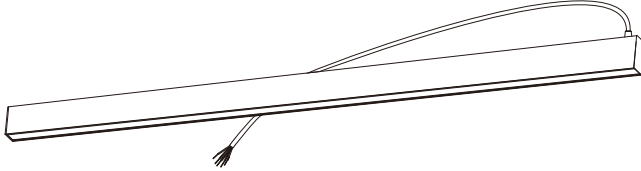

Second style: finished product with separate power cord



① Finished product without power cord

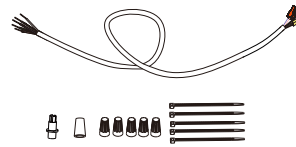

② Power cord kits

Third style: semi-finished product



① Housing



② Down LED module



③ End caps



④ Power cord kits

1.3" PENDANT LED

ARCHITECTURAL LED LUMINAIRE DROP CEILING

⚠ RISK OF FIRE AND ELECTRICAL SHOCK. FIXTURE MUST BE INSTALLED BY A QUALIFIED ELECTRICIAN ONLY IN ACCORDANCE WITH NATIONAL, LOCAL BUILDING AND ELECTRICAL CODES. DISCONNECT POWER AT ELECTRICAL PANEL BEFORE SERVICING.

▶ POWER FEED

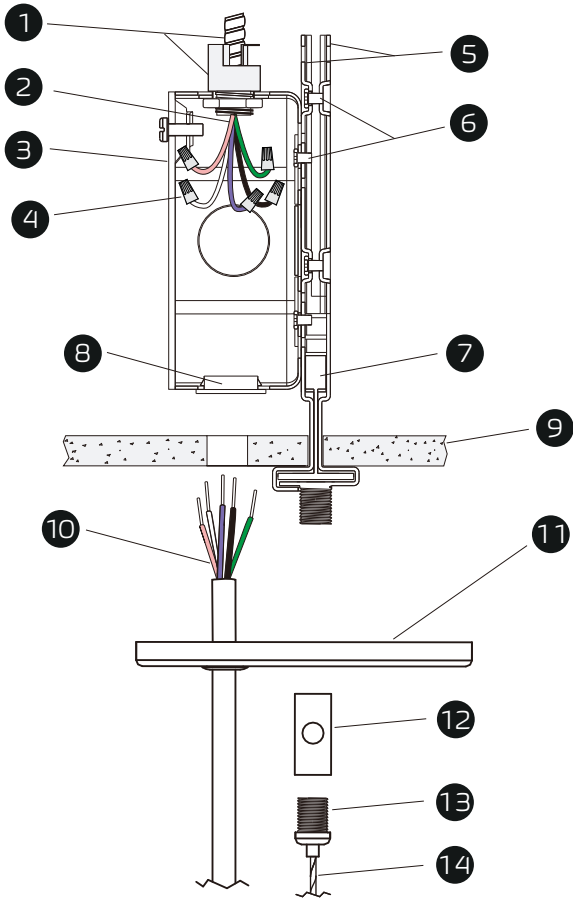

▶ NON POWER SUSPENSION

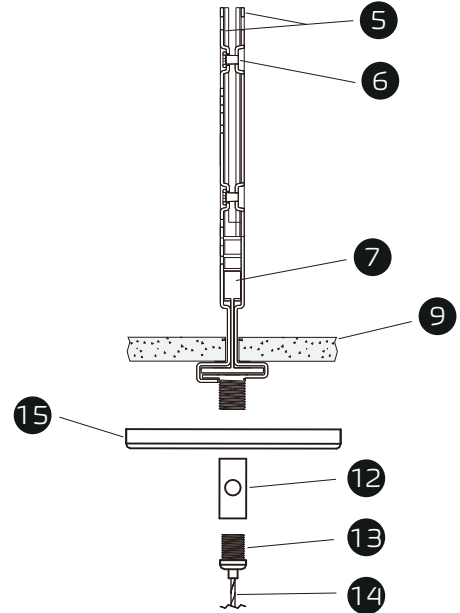

▶ PARTS LIST

- 1 Armored Cable & Connector (By Others)
- 2 Power Cord (By Others)
- 3 4" Octagon Junction Box
- 4 Wire Nut
- 5 Assembled T-grid Clips
- 6 Screw 6#*4
- 7 T-grid (By Others)
- 8 Plastic Grommet
- 9 Ceiling Tile (By Others)
- 10 Power Cord
- 11 4" Power Canopy Kit
- 12 Cable Holder
- 13 Strain Relief Thread Nut
- 14 Aircraft Cable
- 15 2" Canopy

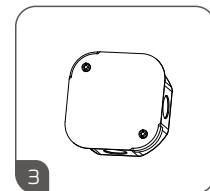

4" Octagon Junction Box

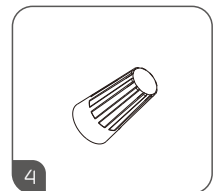

Wire Nut

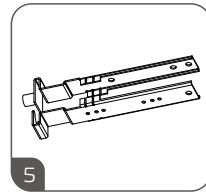

Assembled T-grid Clips

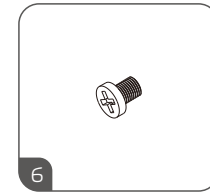

Screw 6#*4

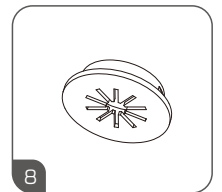

Plastic Grommet

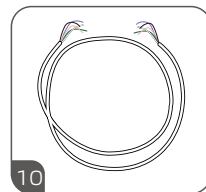

Power Cord

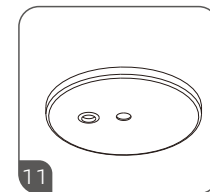

4" Power Canopy Kit

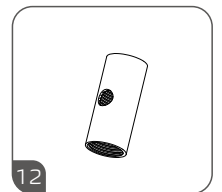

Cable Holder

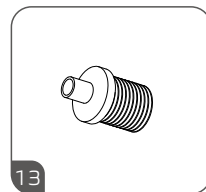

Strain Relief Thread Nut

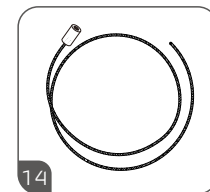

Aircraft Cable

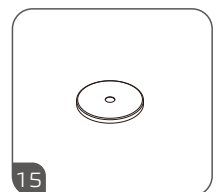

2" Canopy

1.3" PENDANT LED

ARCHITECTURAL LED LUMINAIRE DRY CEILING

⚠️ RISK OF FIRE AND ELECTRICAL SHOCK. FIXTURE MUST BE INSTALLED BY A QUALIFIED ELECTRICIAN ONLY IN ACCORDANCE WITH NATIONAL, LOCAL BUILDING AND ELECTRICAL CODES. DISCONNECT POWER AT ELECTRICAL PANEL BEFORE SERVICING.

▶️ POWER FEED

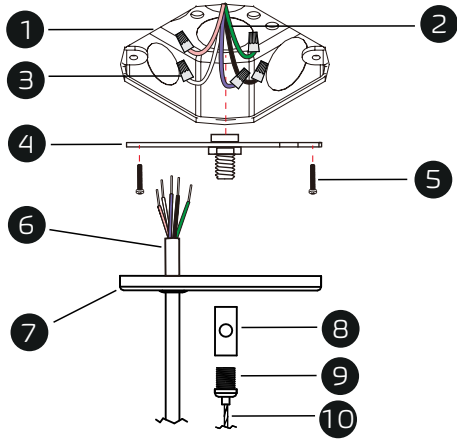

▶️ NON POWER SUSPENSION

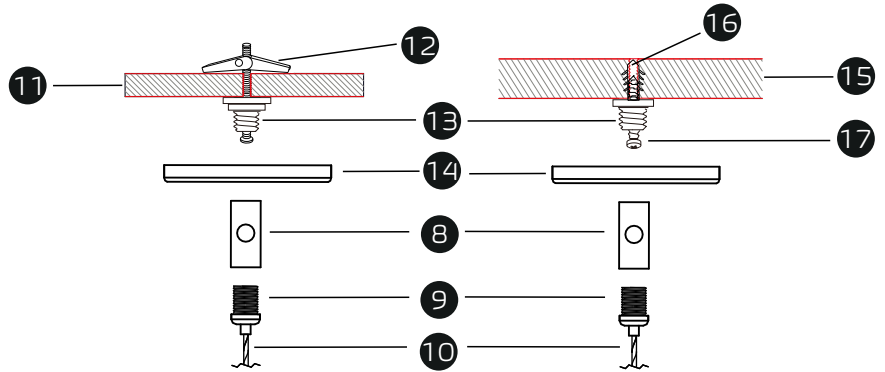

▶️ PARTS LIST

- 1 4" Octagon Junction Box (By Others)
- 2 Power Cord (By Others)
- 3 Wire Nut
- 4 Junction Box Crossbar
- 5 Screw PM4*22
- 6 Power Cord
- 7 4" Power Canopy Kit
- 8 Cable Holder
- 9 Strain Relief Thread Nut
- 10 Aircraft Cable
- 11 Drywall Ceiling (By Others)
- 12 Butterfly Drywall Anchor
- 13 Crimp Stud
- 14 2" Canopy
- 15 Solid Ceiling (By Others)
- 16 Anchor
- 17 Screw PA4*30

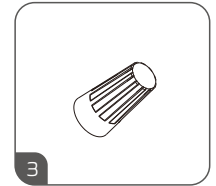

Wire Nut

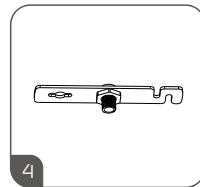

Junction Box Crossbar

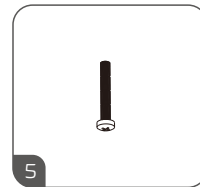

Screw PM4*22

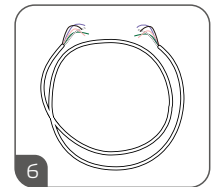

Power Cord

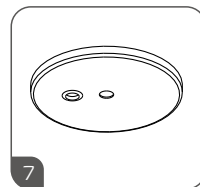

4" Power Canopy Kit

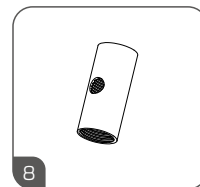

Cable Holder

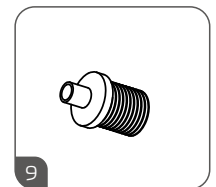

Strain Relief Thread Nut

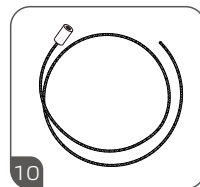

Aircraft Cable

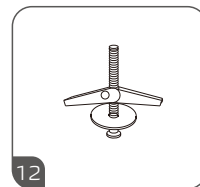

Butterfly Drywall Anchor

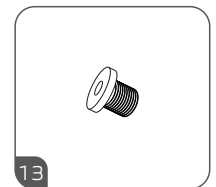

Crimp Stud

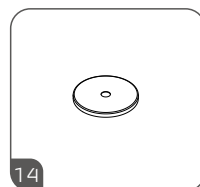

2" Canopy



Anchor

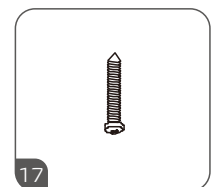

Screw PA4*30

1.3" PENDANT LED

ARCHITECTURAL LED LUMINAIRE INDEPENDENT INSTALLATION

⚠️ RISK OF FIRE AND ELECTRICAL SHOCK. FIXTURE MUST BE INSTALLED BY A QUALIFIED ELECTRICIAN ONLY IN ACCORDANCE WITH NATIONAL, LOCAL BUILDING AND ELECTRICAL CODES. DISCONNECT POWER AT ELECTRICAL PANEL BEFORE SERVICING.

IMPORTANT

1. Read all instructions.
2. Install in accordance with national and local electrical code regulations.
3. This product is intended to be installed and serviced by a qualified, licensed electrician.
4. Do not install in wet locations. For dry and damp use only.
5. Turn off electrical power before installing or servicing fixture in any way.
6. To reduce the risk of fire and overheating, make sure all connections are tight.
7. Under no circumstances can the lighting fixture be covered with heat insulation gasket or similar materials.
8. The maximum connection of each input line is 40FT(1200CM) in 120AC, 80FT (2400CM) in 230AC, 100FT(3000CM) in 277AC.

SHOCK HAZARD

⚡ May result in serious injury or death. Turn power OFF at circuit breaker prior to installation or servicing.

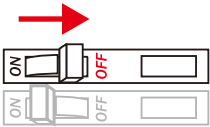

PRE-INSTALLATION

Assemble Power Cord

1. Take off the end cap, insert the cord holder into the power code location as shown.
2. Take off LED modular, thread the power code into the cord holder as shown.
3. Wiring. Must connect connectors with corresponding colors as shown.
4. Fix the power code with holder nut, remount LED modular and end cap.

INDEPENDENT INSTALLATION

1 Hang Luminaire

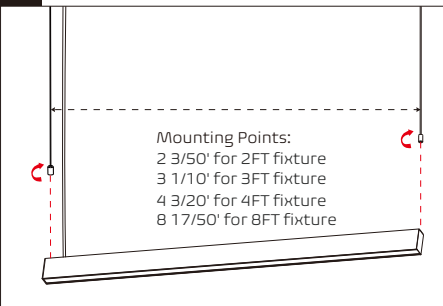

Screw both bottom parts of aircraft cables clockwise and secure them on the top of housing making sure they hang the lights.

2 Complete

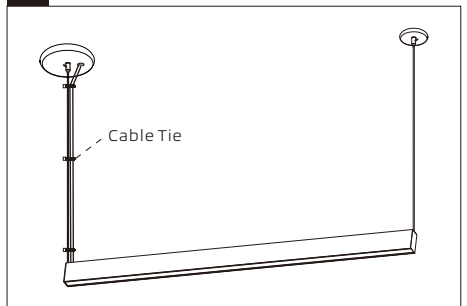

Use the cable tie every 2.95" to keep the electric wire going up along with the wire rope.

Note: Adjust the height of luminaire. Luminaire can be raised by pulling cable through the gripper and can be lowered by depressing the top cylinder on the gripper which pulls the luminaire down.

WIRING

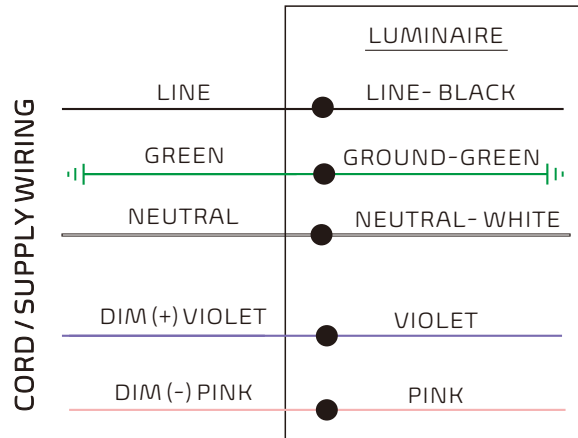

Please isolate two dimming wires by P2 terminal individually if no need dimming; **MUST connect wires with corresponding colors as shown.**

1.3" PENDANT LED

ARCHITECTURAL LED LUMINAIRE MULTIPLE LUMINAIRES CONNECTION

⚠ RISK OF FIRE AND ELECTRICAL SHOCK. FIXTURE MUST BE INSTALLED BY A QUALIFIED ELECTRICIAN ONLY IN ACCORDANCE WITH NATIONAL, LOCAL BUILDING AND ELECTRICAL CODES. DISCONNECT POWER AT ELECTRICAL PANEL BEFORE SERVICING.

JOINER OPTIONS

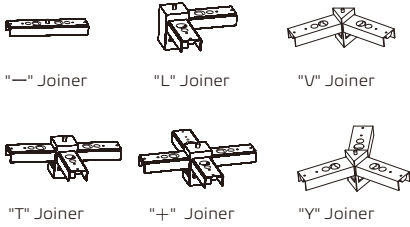

Note: It needs 2 inputs if using joiner "T", "+ " and "Y".

ACCESSORY



Note: Silicone seal is used to seal seams that may appear at both ends of luminaires when multiple connections.

BEFORE CONNECTING

Disassemble Luminaires

Start of run (SoR):
Remove the end cap without power code, and take the LED module out.

Middle of run (MoR):
Remove both end caps, and take the LED module out.

End of run (EoR):
Remove the end cap without power code, and take the LED module out.

LINE CONNECTION

1 Install joiners

SoR	MoR	MoR	EoR
Mounting Points: 2 2/25' for 2FT fixture 3 3/25' for 3FT fixture 4 9/53' for 4FT fixture 8 7/20' for 8FT fixture	Mounting Points: 2 8/89' for 2FT fixture 3 7/50' for 3FT fixture 4 15/79' for 4FT fixture 8 27/73' for 8FT fixture	Mounting Points: 2 2/25' for 2FT fixture 3 3/25' for 3FT fixture 4 9/53' for 4FT fixture 8 7/20' for 8FT fixture	

Screw the joiner "—" to the MoR aircraft cable in turn.

2 Hang luminaire and wiring - SoR

▲ Adjust the height of luminaire.
Luminaire can be raised by pulling cable through the gripper and can be lowered by depressing the top cylinder on the gripper which pulls the luminaire down.

2-1: Insert the joiner "—" into luminaire from one side and fix it with screws.
2-2: Screw both bottom parts of aircraft cables clockwise and secure them on the top of housing making sure they hang the lights.

3 Repeat Hang and join steps - MoR to EoR

3-1: Zip tight power cord & aircraft suspension cable with the cable tie every 2.95".
3-2: Connect the quick connectors properly.
3-3: Insert all the LED Modules into the housing from SoR to EoR in turn.

Wiring
Must connect connectors with corresponding colors as shown.

4 Complete

Optional 40' Continuous Roll-out Lens

Diffuser must fully enclose the LED module compartment.

Diffuser (Optional Accessories)
Optional continuous roll-out lens which can reach seamless continue runs up to 40' is available.

1.3" PENDANT LED

ARCHITECTURAL LED LUMINAIRE MULTIPLE LUMINAIRES CONNECTION

⚠ RISK OF FIRE AND ELECTRICAL SHOCK. FIXTURE MUST BE INSTALLED BY A QUALIFIED ELECTRICIAN ONLY IN ACCORDANCE WITH NATIONAL, LOCAL BUILDING AND ELECTRICAL CODES. DISCONNECT POWER AT ELECTRICAL PANEL BEFORE SERVICING.

L SHAPE CONNECTION

- ▲ For "T", "+", "Y" shape or other geometric shapes, all subject to the "L" shape installation.
- ▲ It needs 2 inputs if using joiner "T", "+" and "Y".

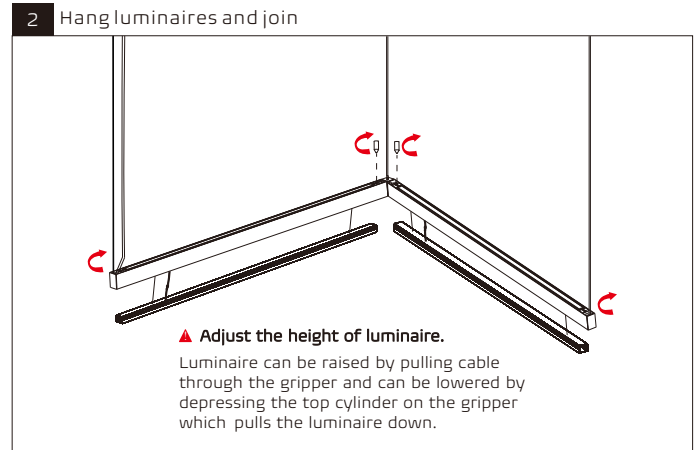
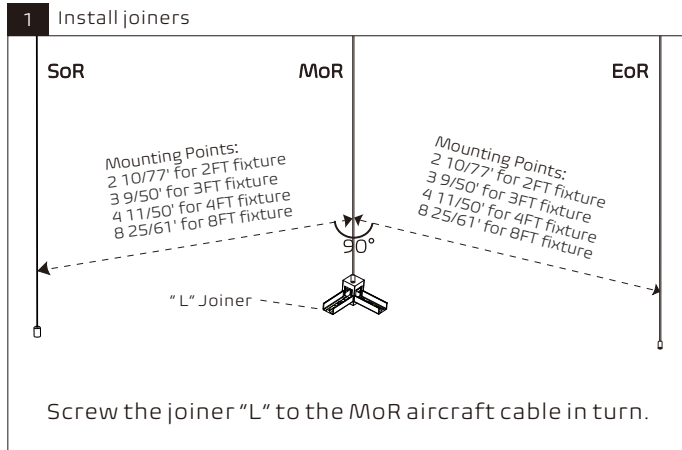

- 2-1: Insert the joiner "L" into luminaire from one side and fix it with screws.
2-2: Screw both bottom parts of aircraft cables clockwise and secure then on the top of housing making sure they hang the lights.

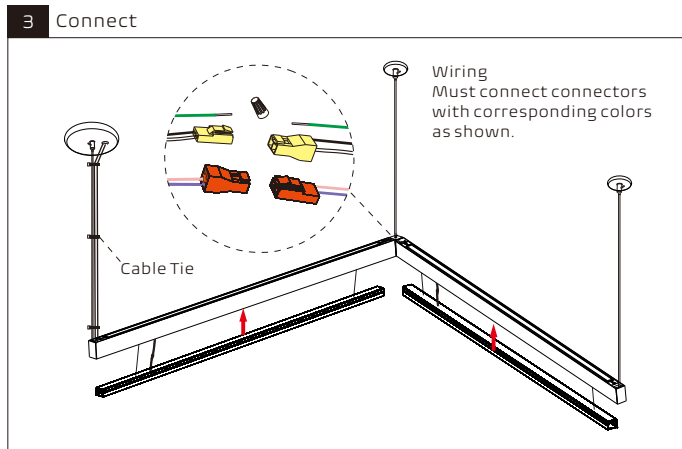

- 3-1: Zip tight power cord & aircraft suspension cable with the cable tie every 2.95".
3-2: Connect the quick connectors properly.
3-3: Insert all the LED Modules into the housing from SoR to EoR in turn.

